

TR3シリーズ読取範囲

リーダライタ：ミドルレンジ(300mW出力)
ICタグ：カードサイズ(Tag-it HF-I)

Ver. 1.00

発行日：2010年2月1日

 **タカヤ株式会社**
RF事業推進部

■構成及び測定条件

下図のようにアンテナとICタグが正対する位置関係において、相互の間隔毎に通信可能な範囲を示す。

| | | |
|------------------------|--|-------|
| リーダライタ | ミドルレンジ 300mW出力タイプ | |
| アンテナ | 型番(外形サイズ) | 参照頁 |
| | TR3-A101-1 (115×135mm) | P. 3 |
| | TR3-A201-2 (60×65mm) | P. 8 |
| | TR3-A301-3 (15×52.5mm) | P. 11 |
| | TR3-A401 (15×30mm) | P. 14 |
| | TR3-HA101 (150mm φ) | P. 17 |
| | TR3-HA201 (200mm φ) | P. 21 |
| | TR3-HA301 (約153×230mm) | P. 25 |
| | TR3-SA101 (324×254mm) | P. 28 |
| TR3-SA101M (324×254mm) | P. 33 | |
| ICタグ | カードサイズ(Tag-it HF-I) | |
| 測定条件 | 連続インベントリモード(UIDのみ取得)を使用 周囲に金属のない自由空間上にて測定 | |

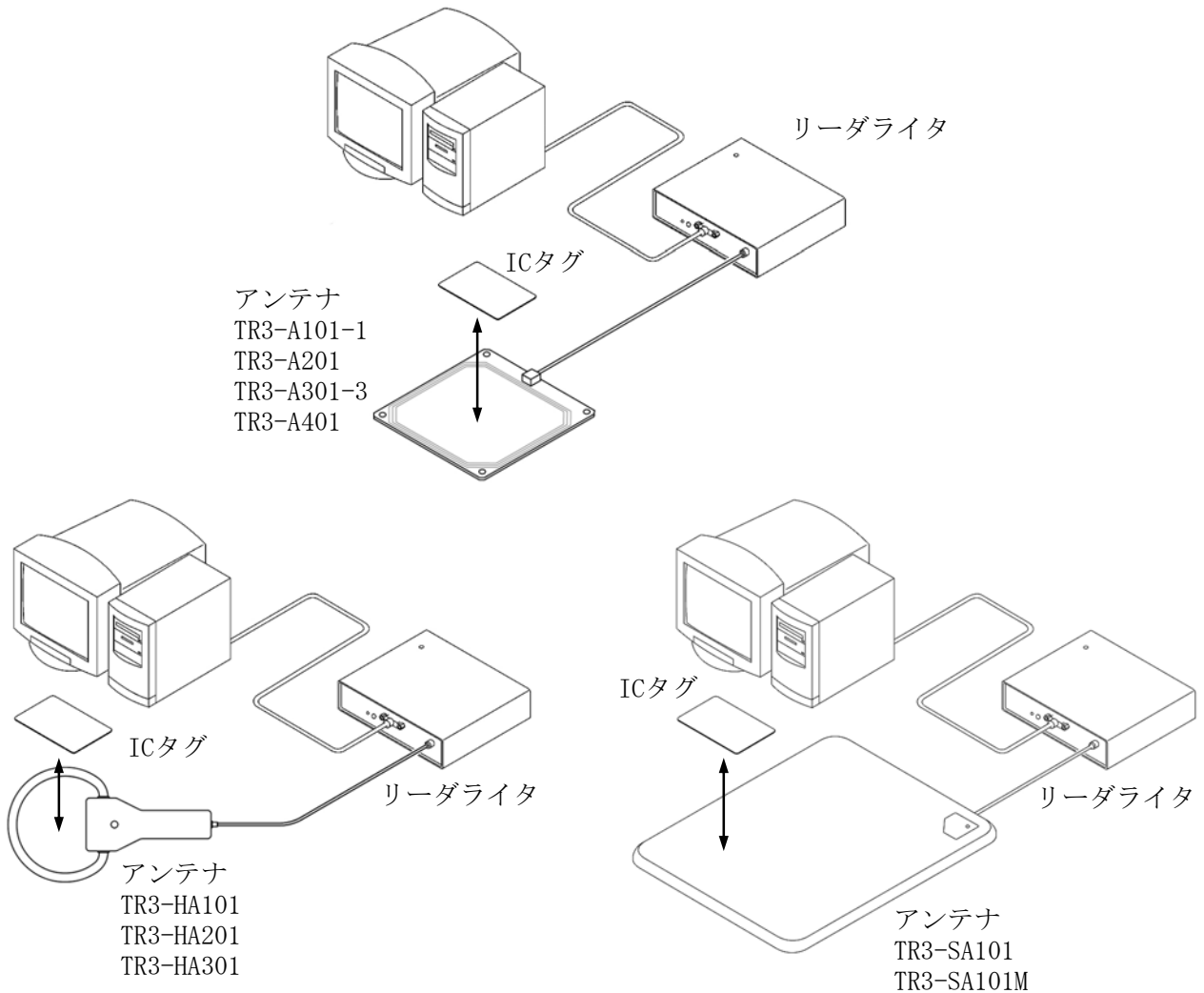

■使用上の注意

使用環境、使用するICタグにより性能は異なるため、あくまで参考データとして使用していただき、運用の際は実際の環境での確認が必要になります。

■ 読取範囲データ

TR3-A101-1 読取範囲(1/5)

対象アンテナ : TR3-A101-1(外形 : 115×135mm)
 ICタグ : カードサイズ(Tag-it HF-I)
 交信距離 : MAX 28cm

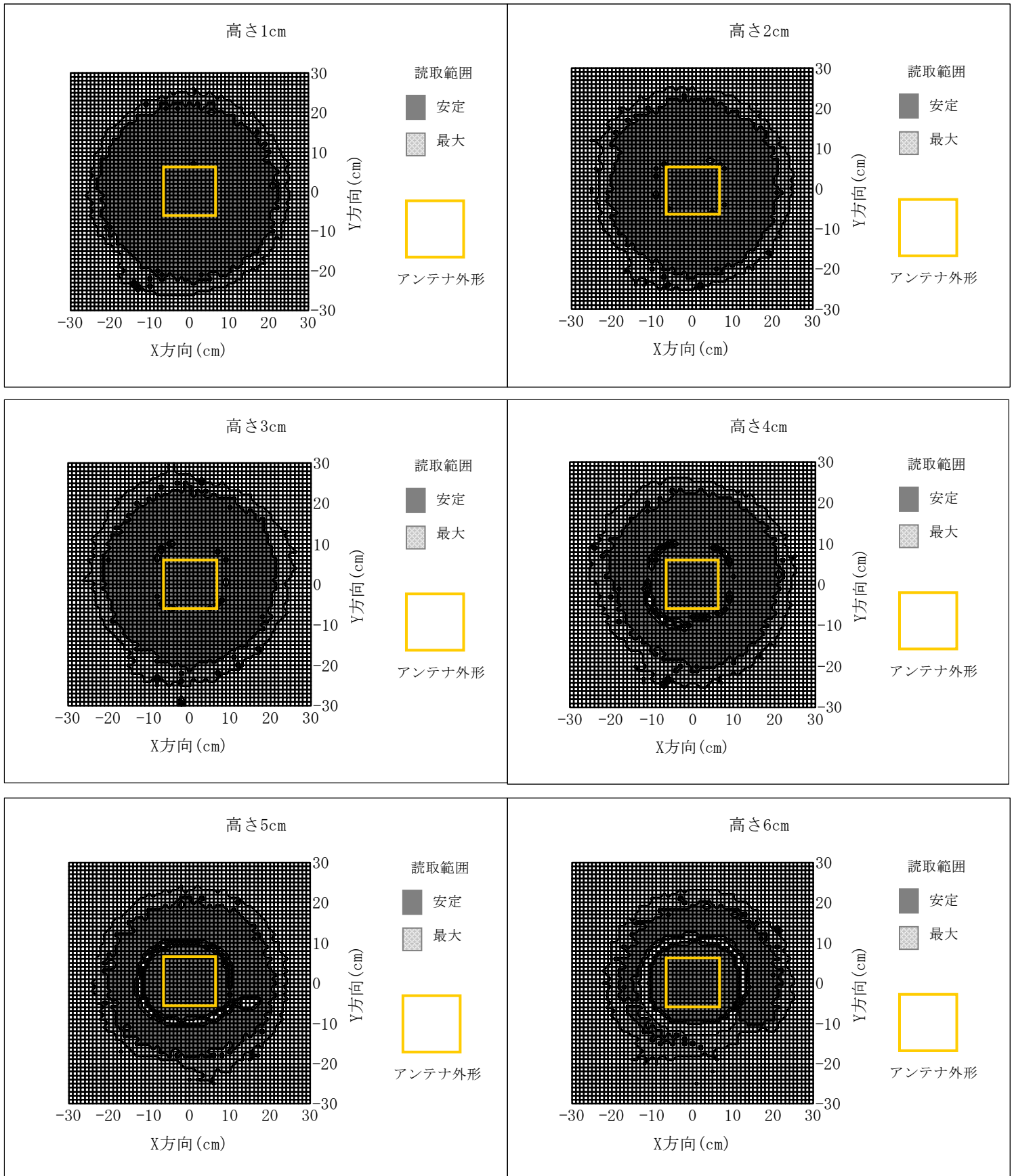

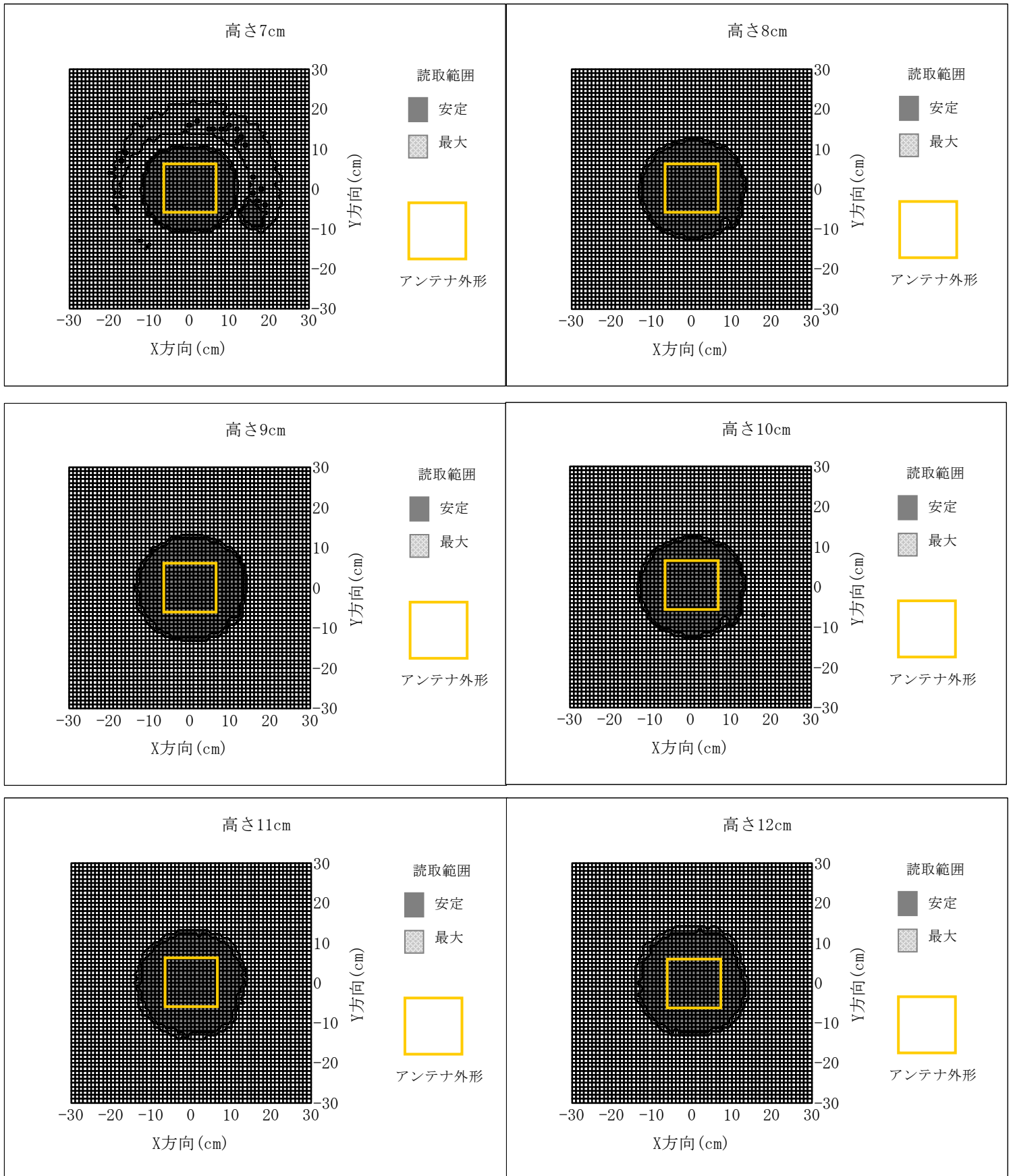

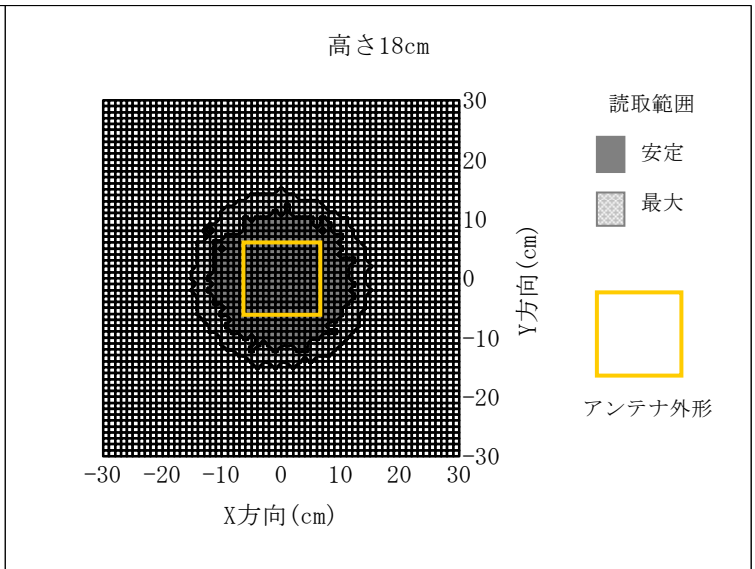
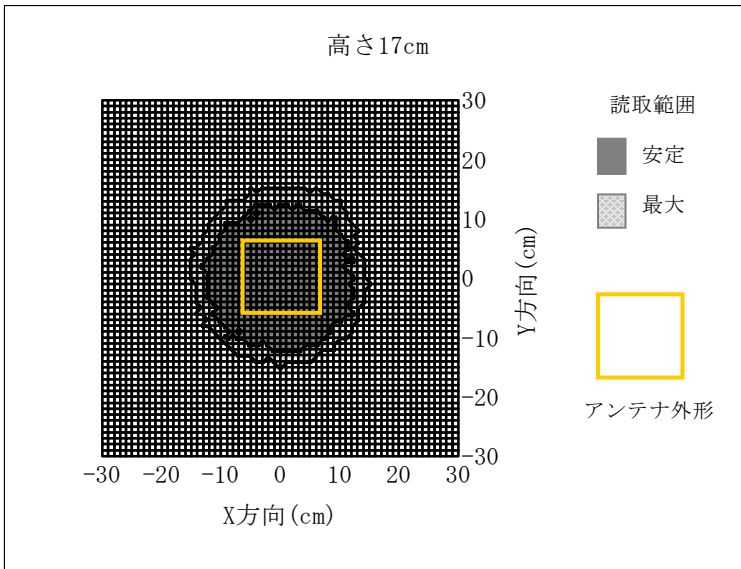
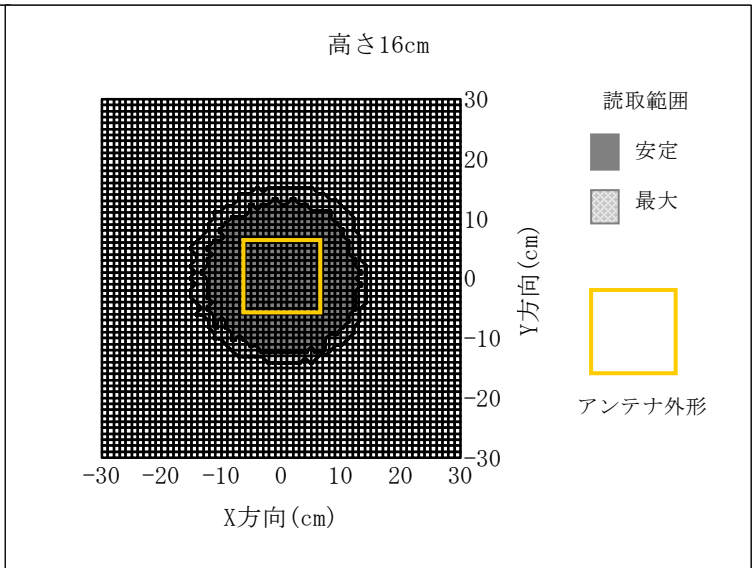
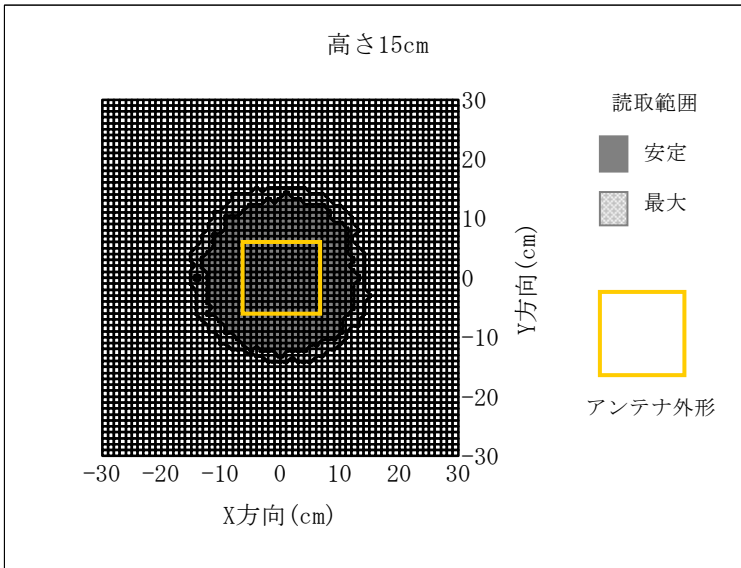
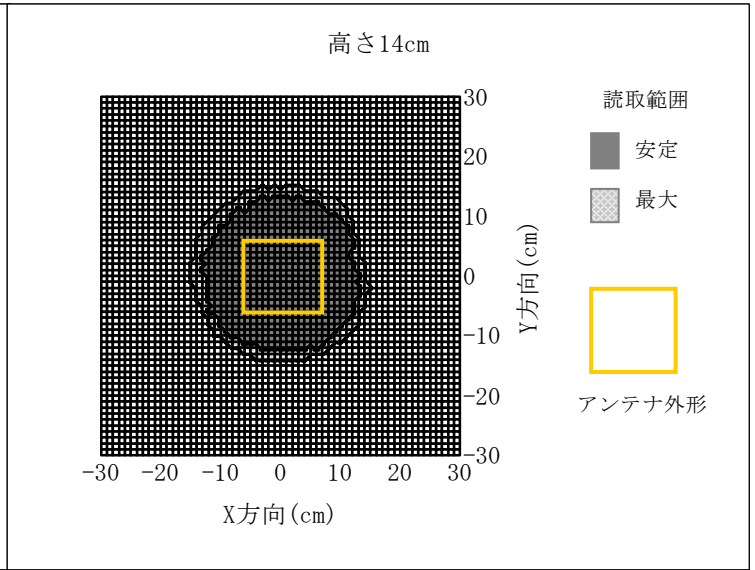
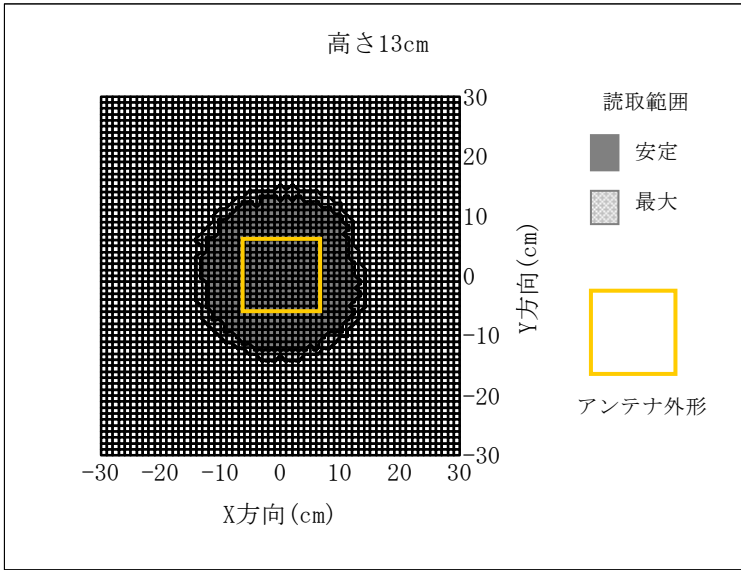

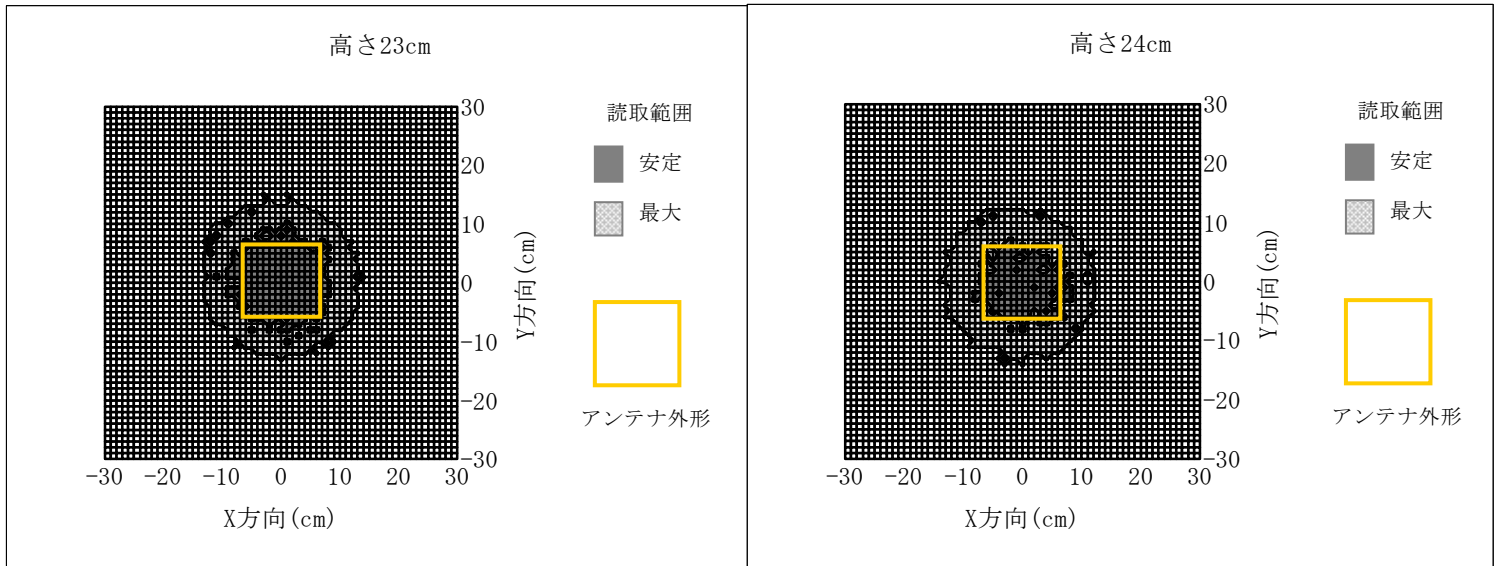
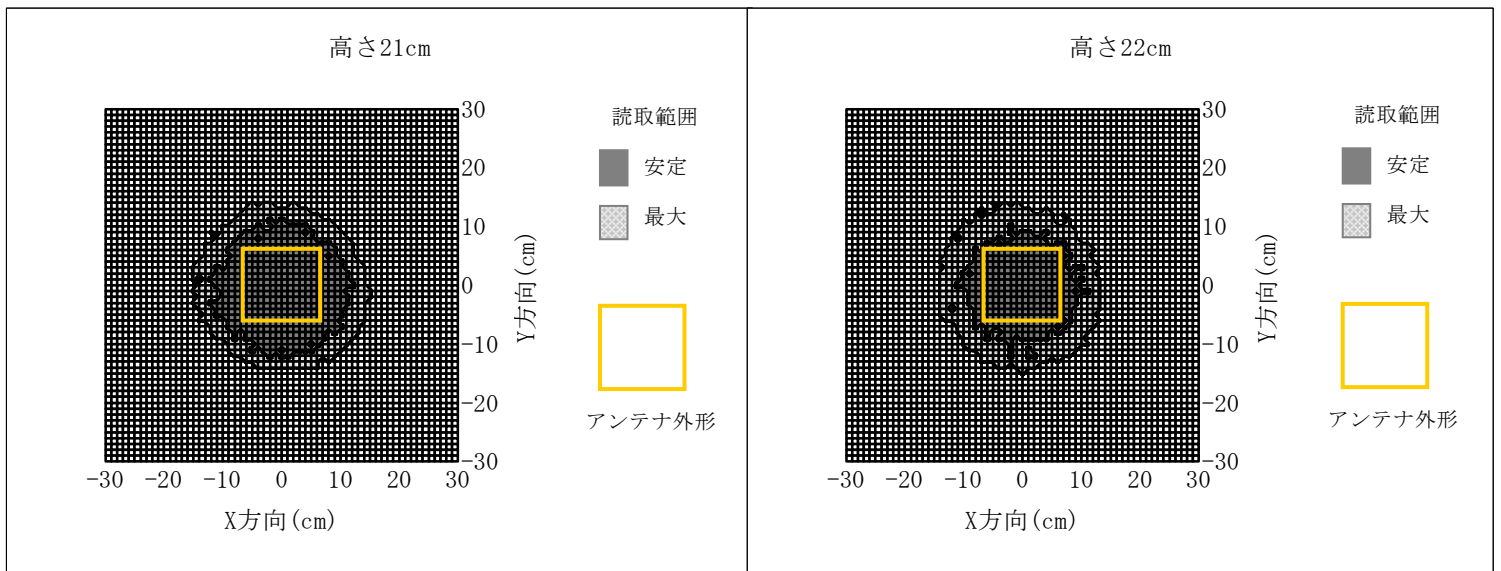
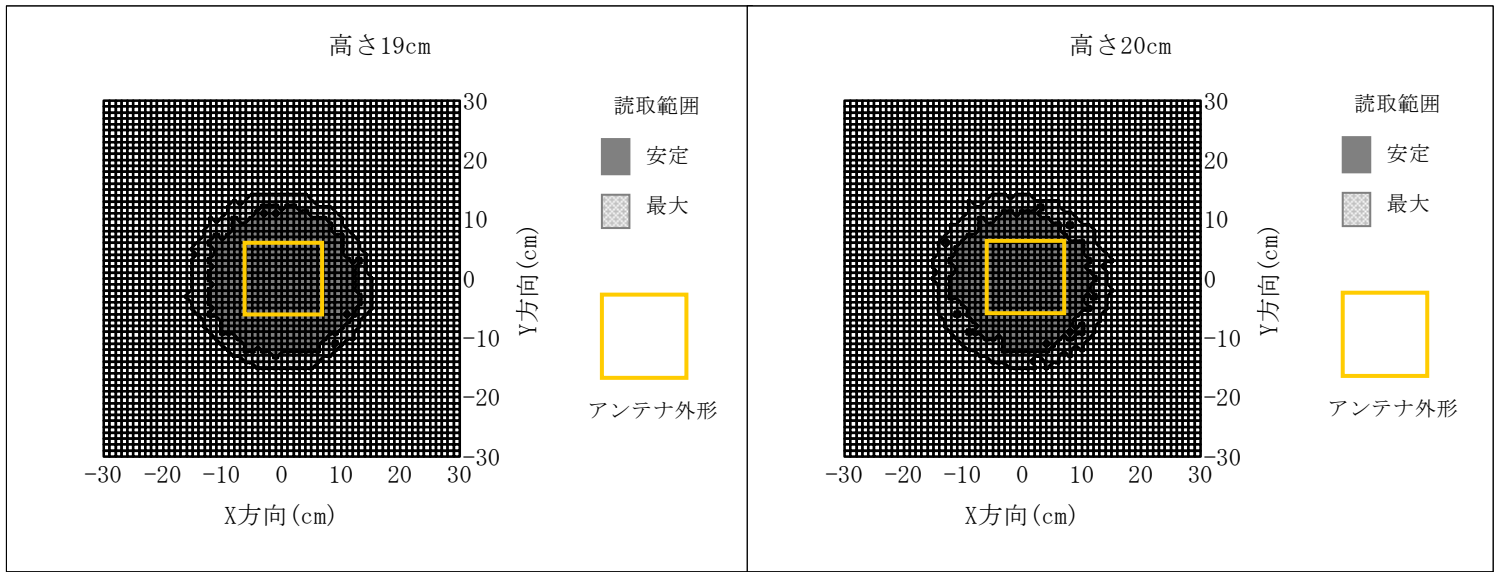

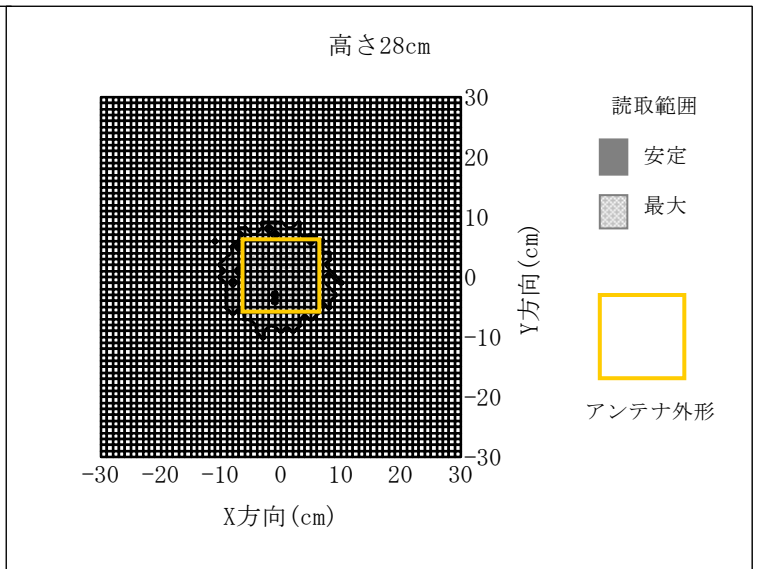
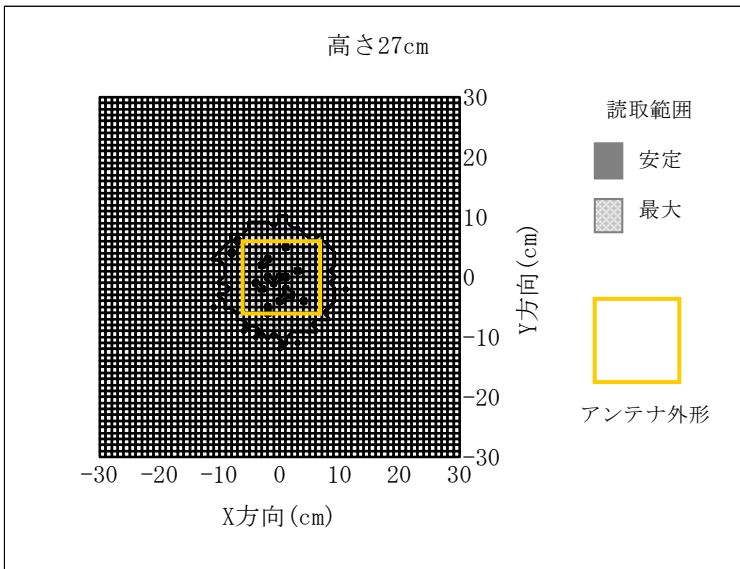
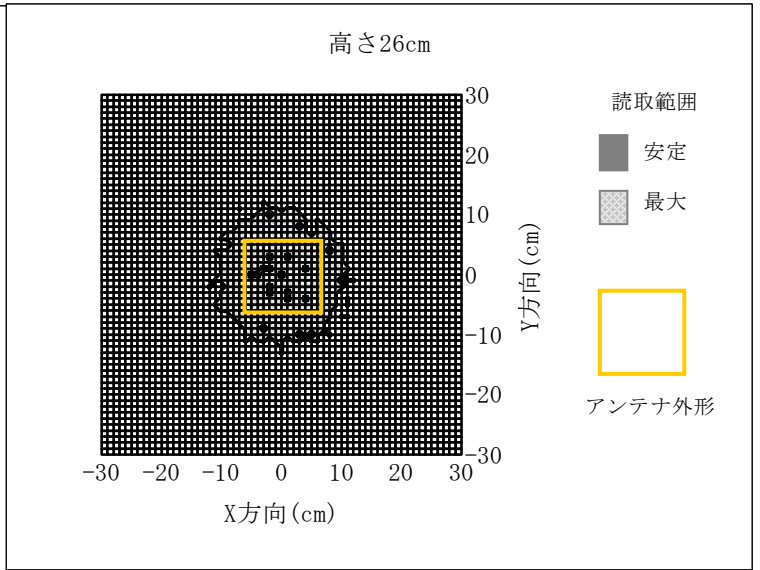
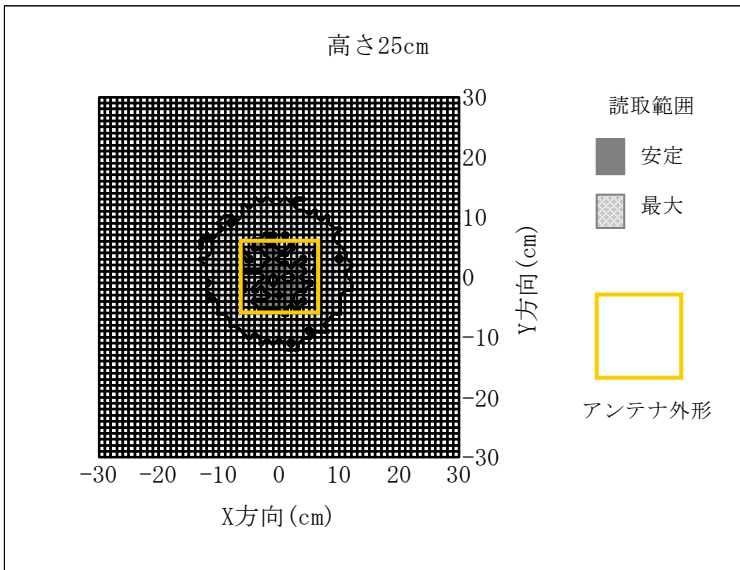

対象アンテナ : TR3-A201-2(外形 : 60×65mm)
 ICタグ : カードサイズ(Tag-it HF-I)
 交信距離 : MAX 18cm

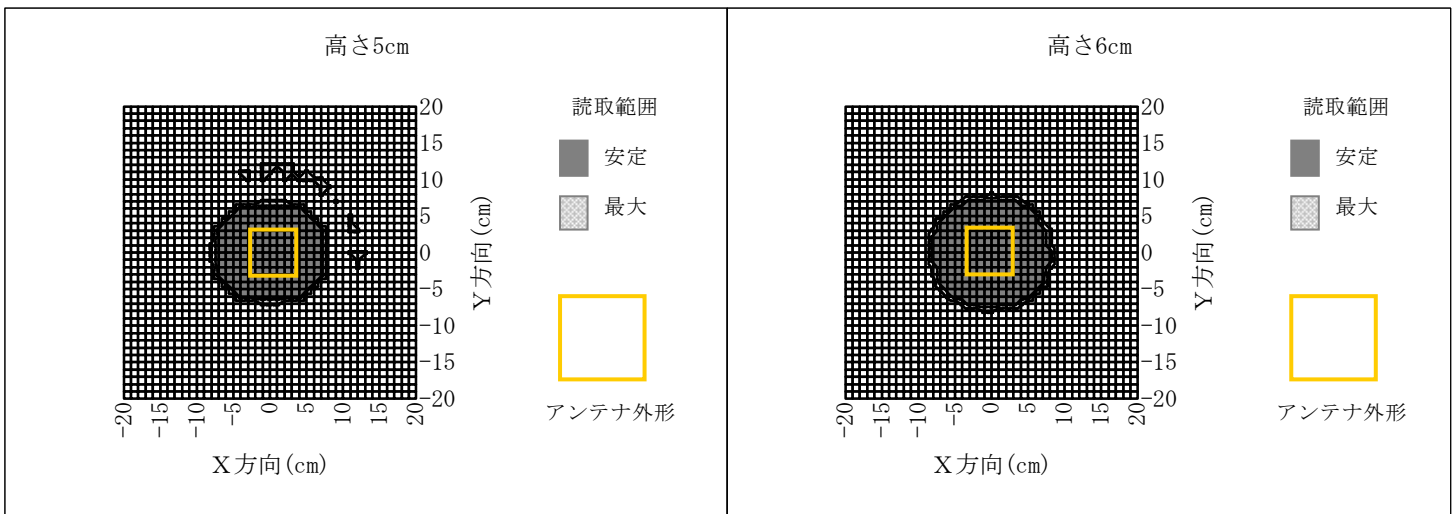
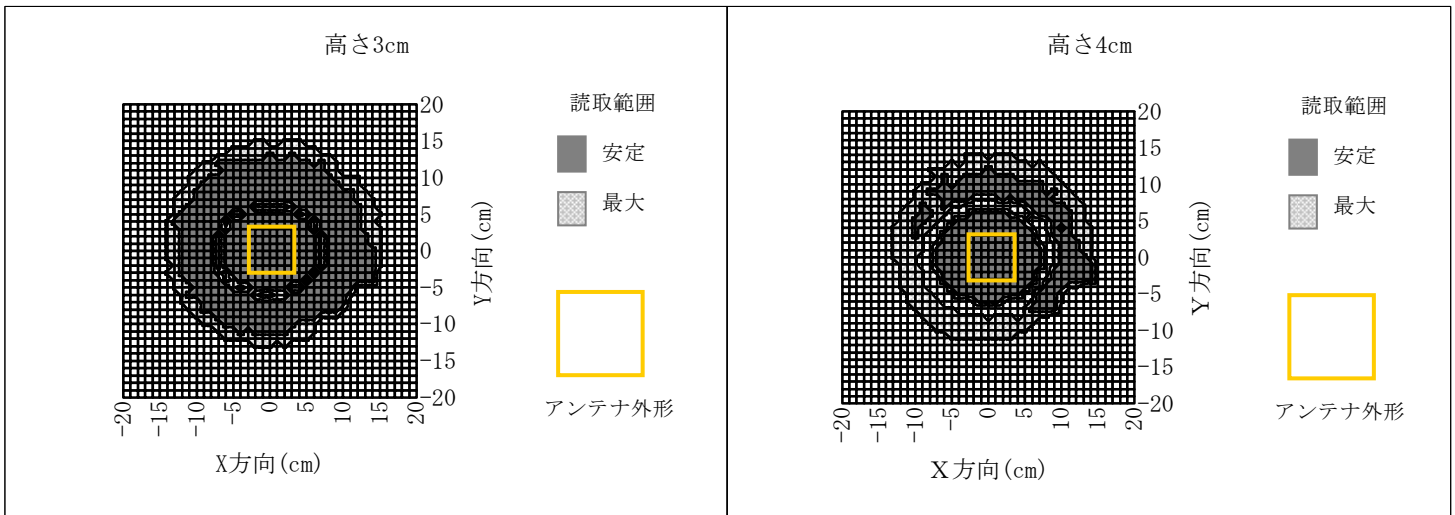
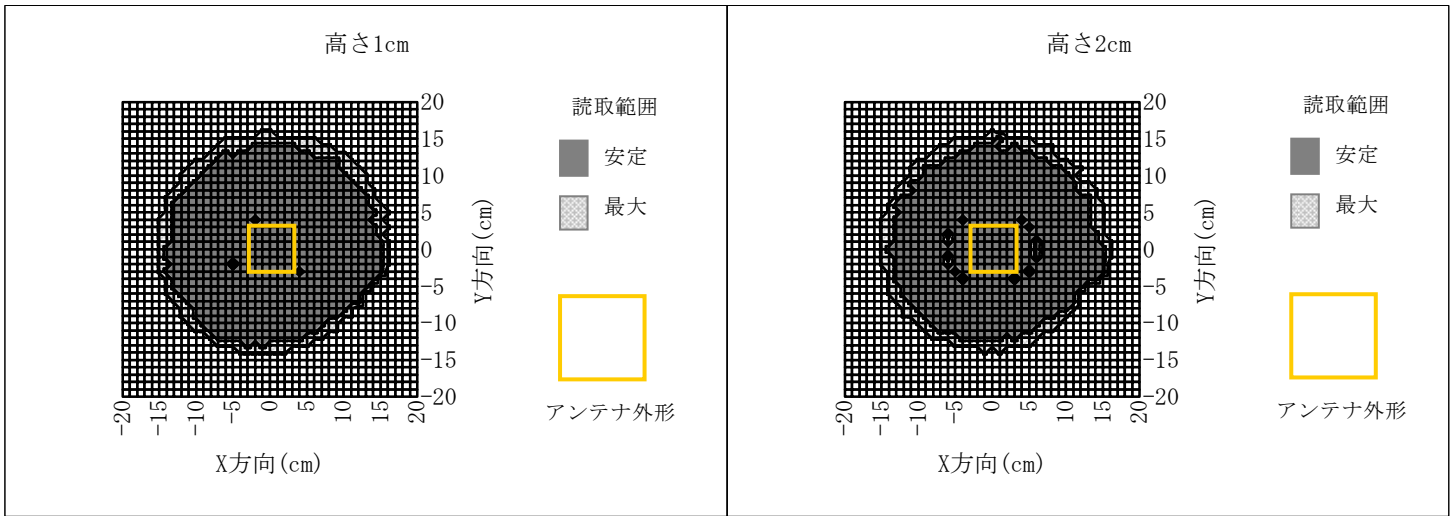

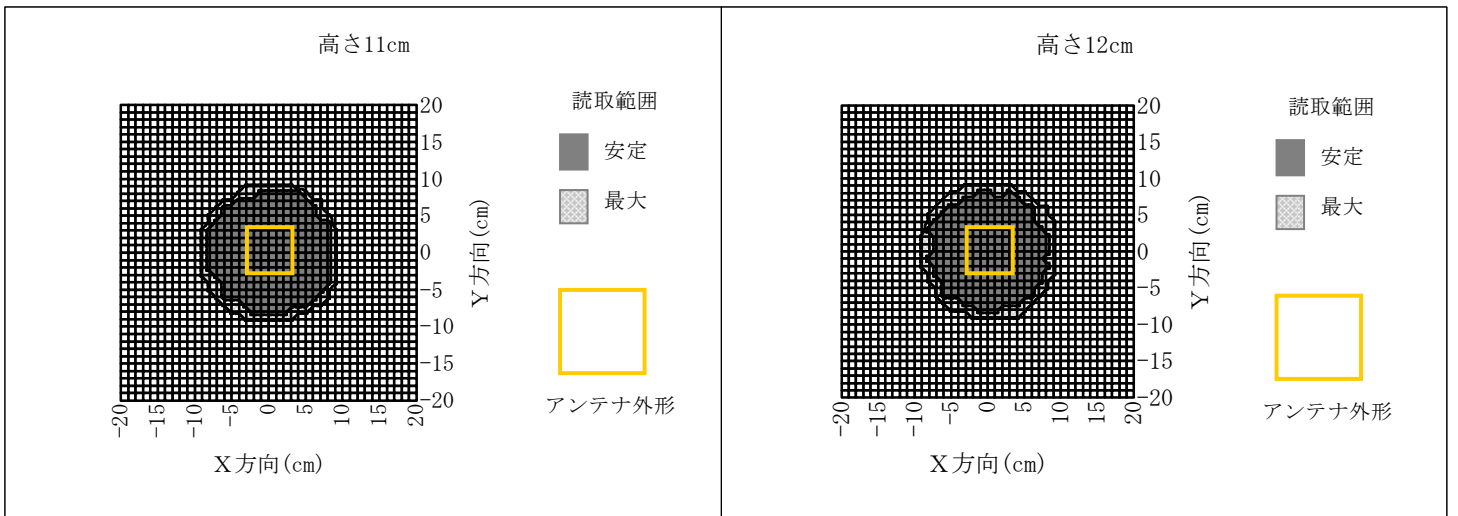
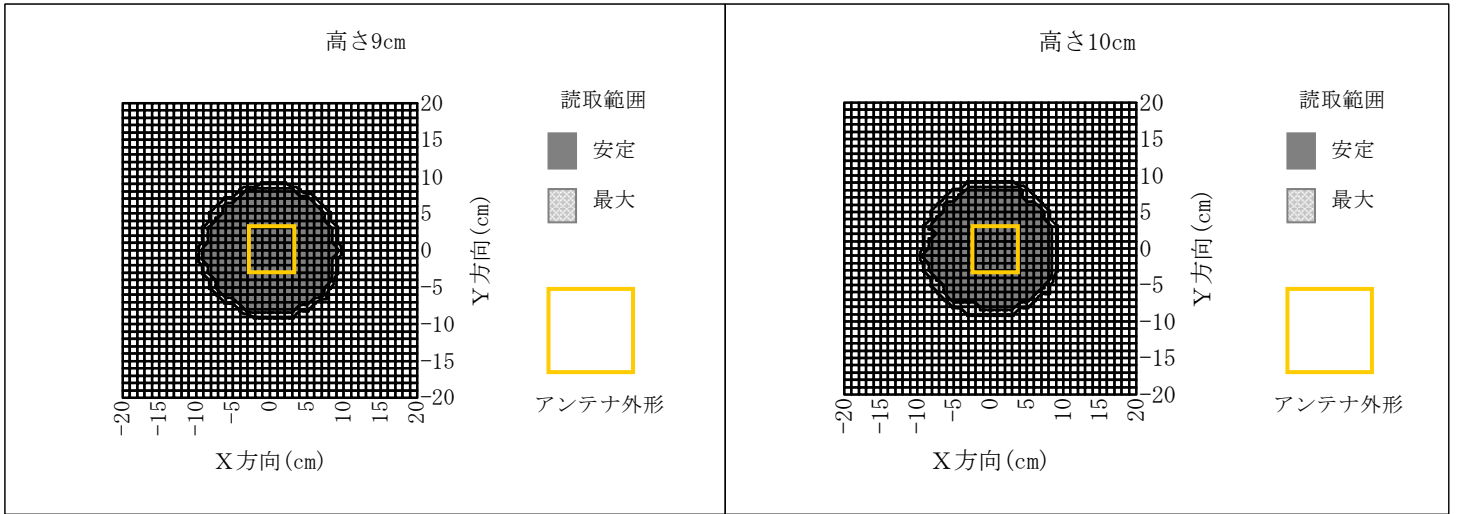
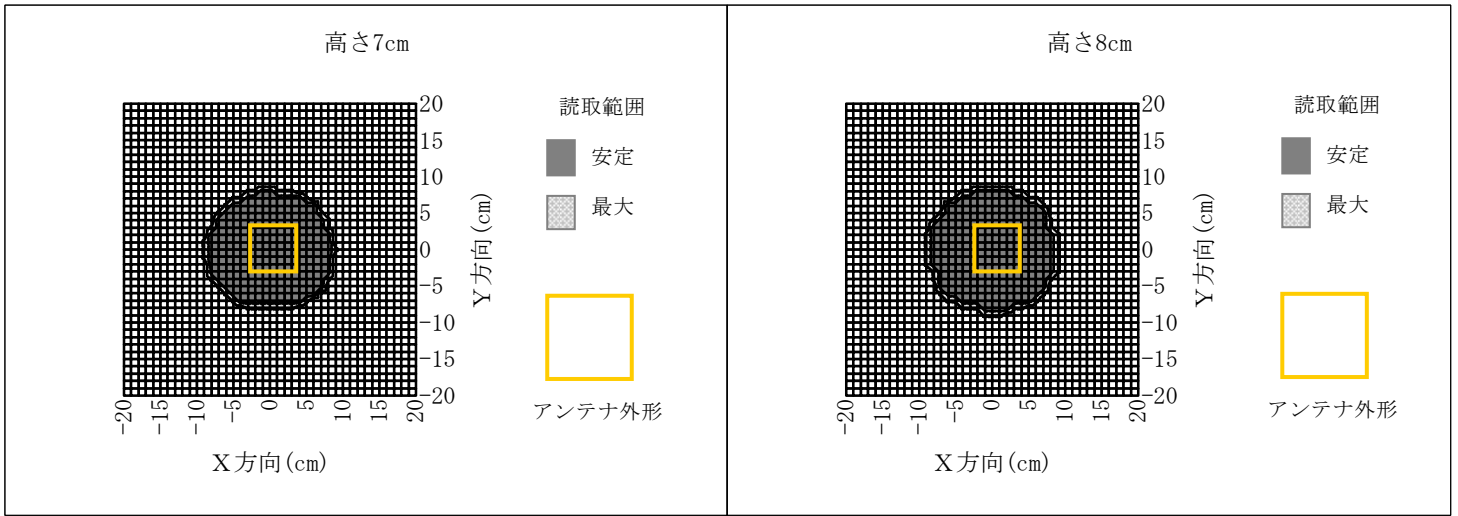

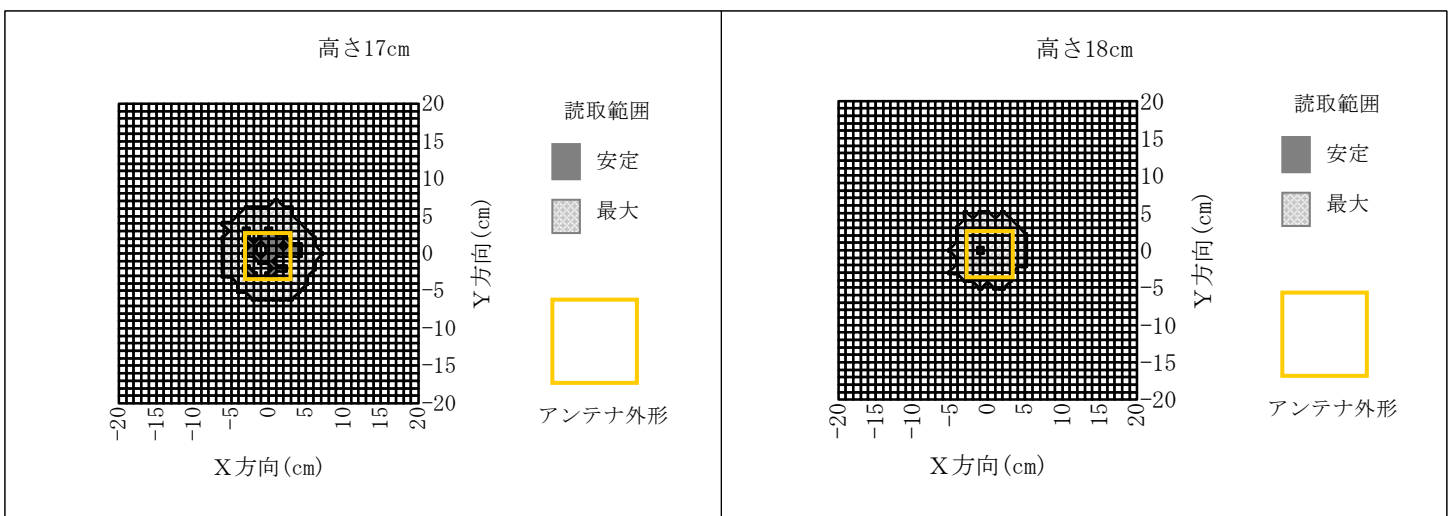
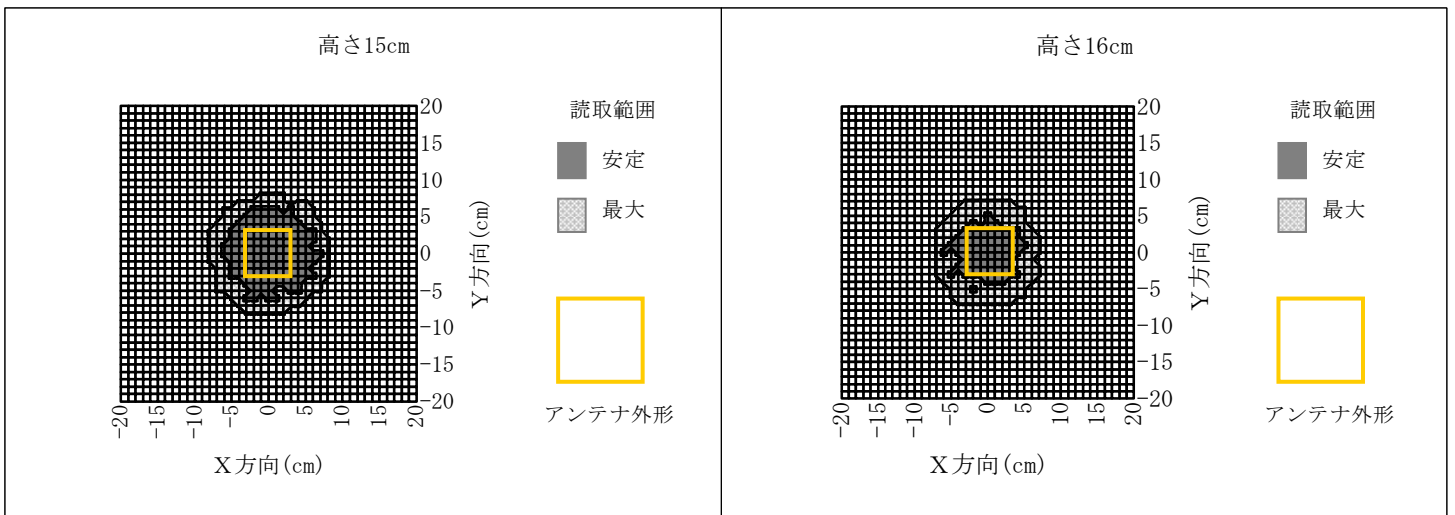
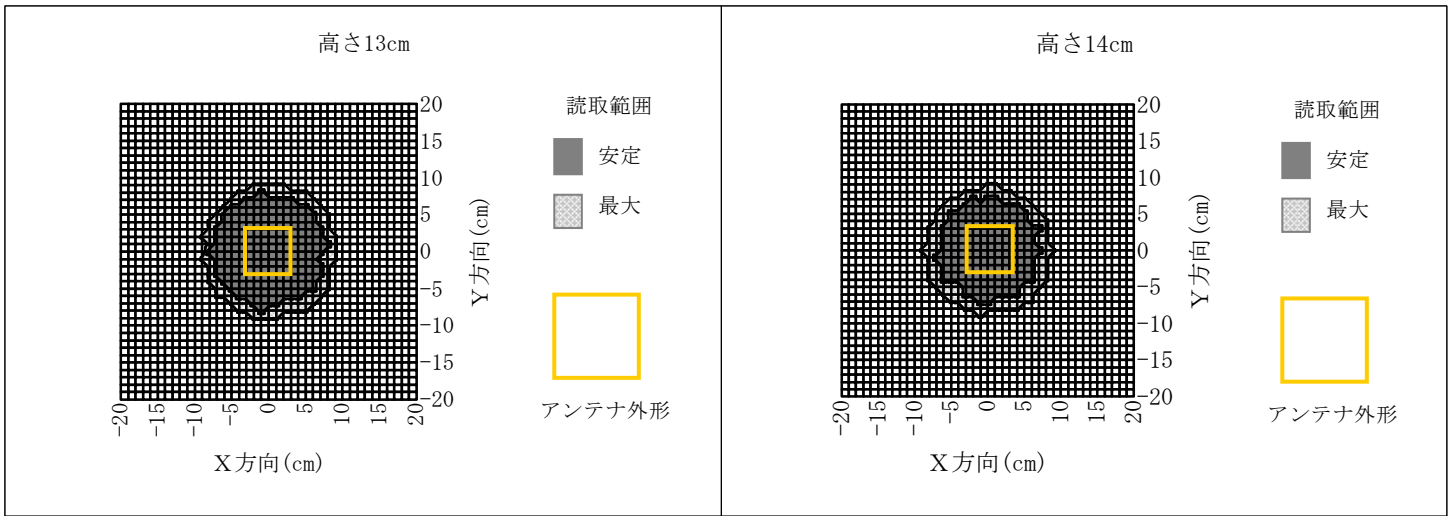

対象アンテナ : TR3-A301-3(外形 : 15×52.5mm)
 ICタグ : カードサイズ(Tag-it HF-I)
 交信距離 : MAX 14cm

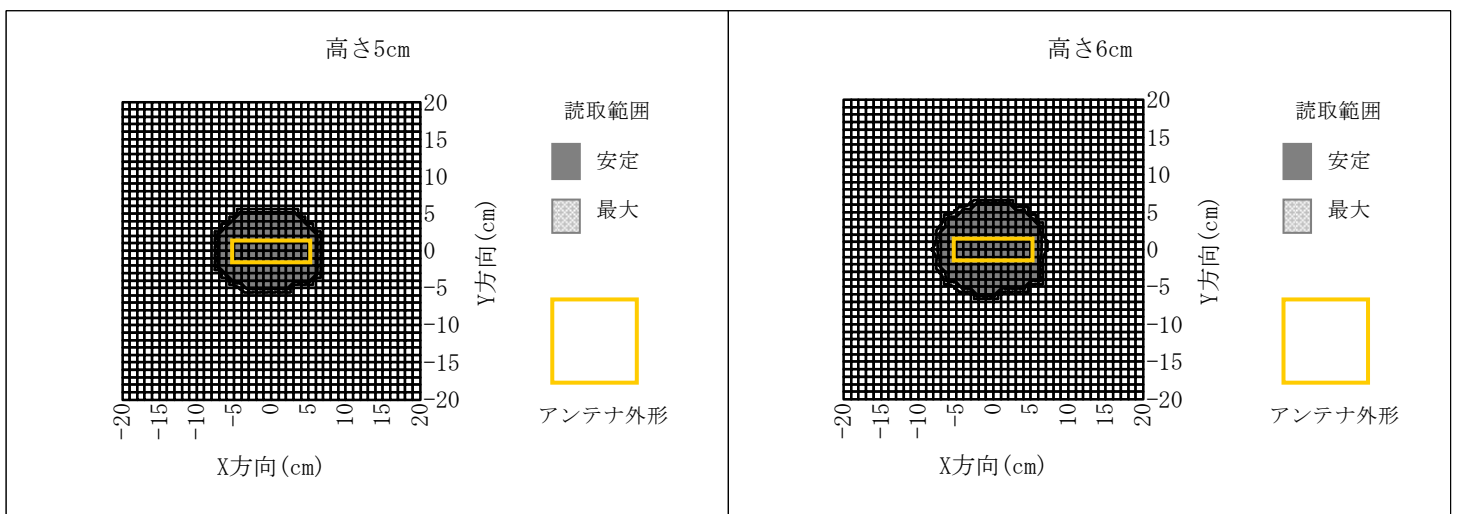
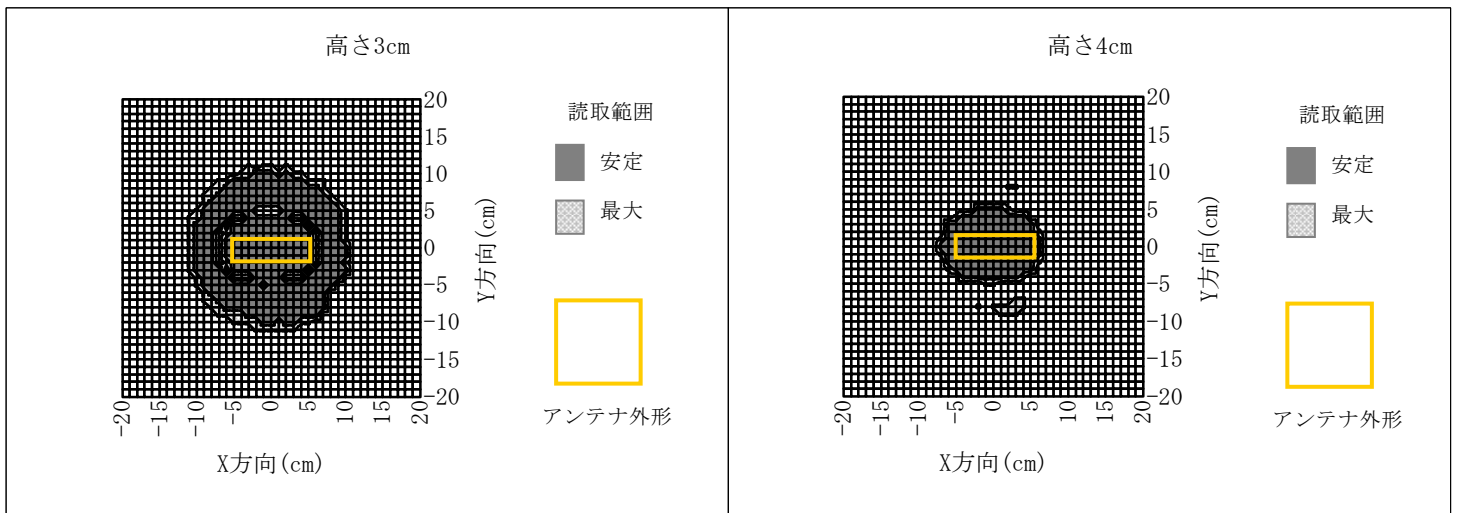
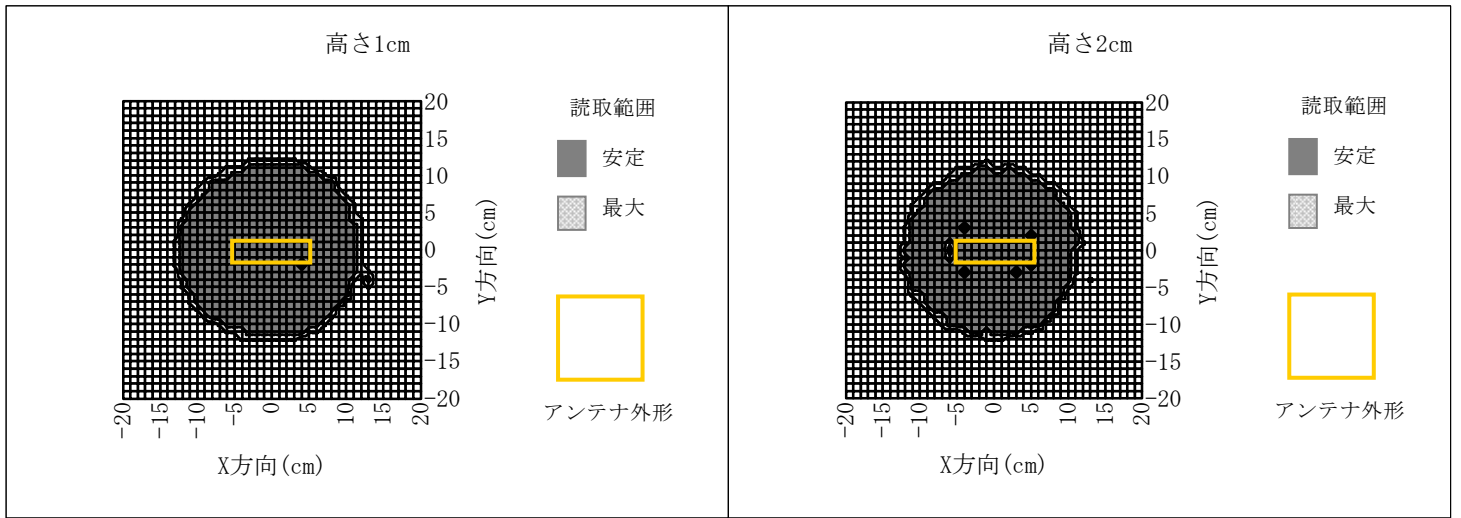

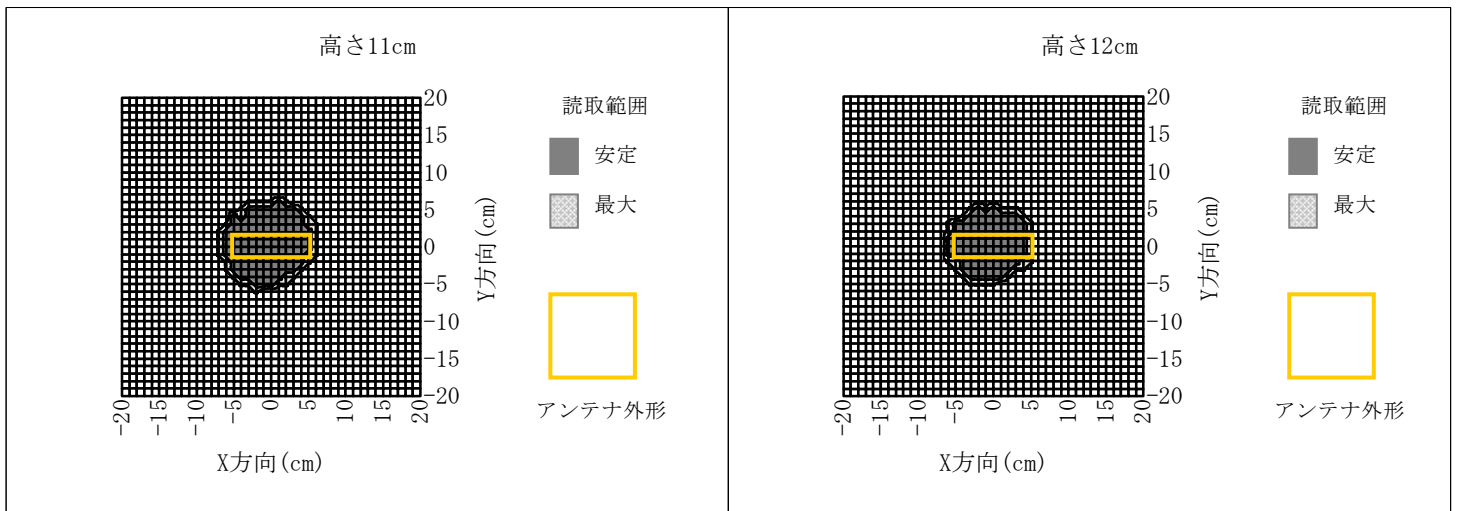
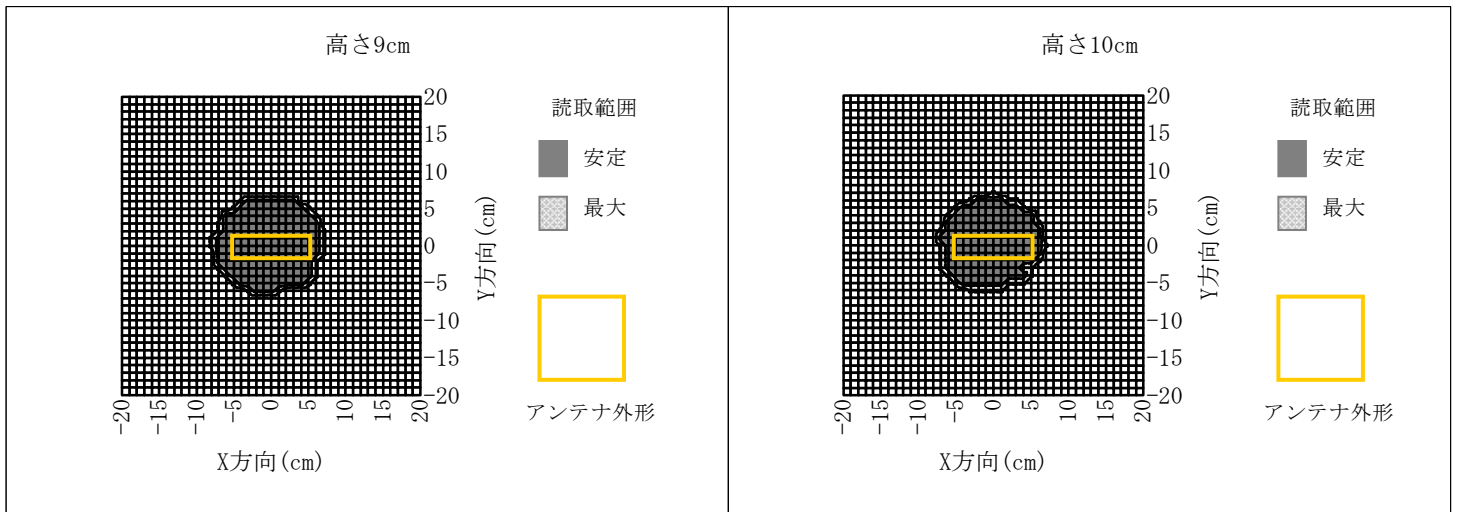
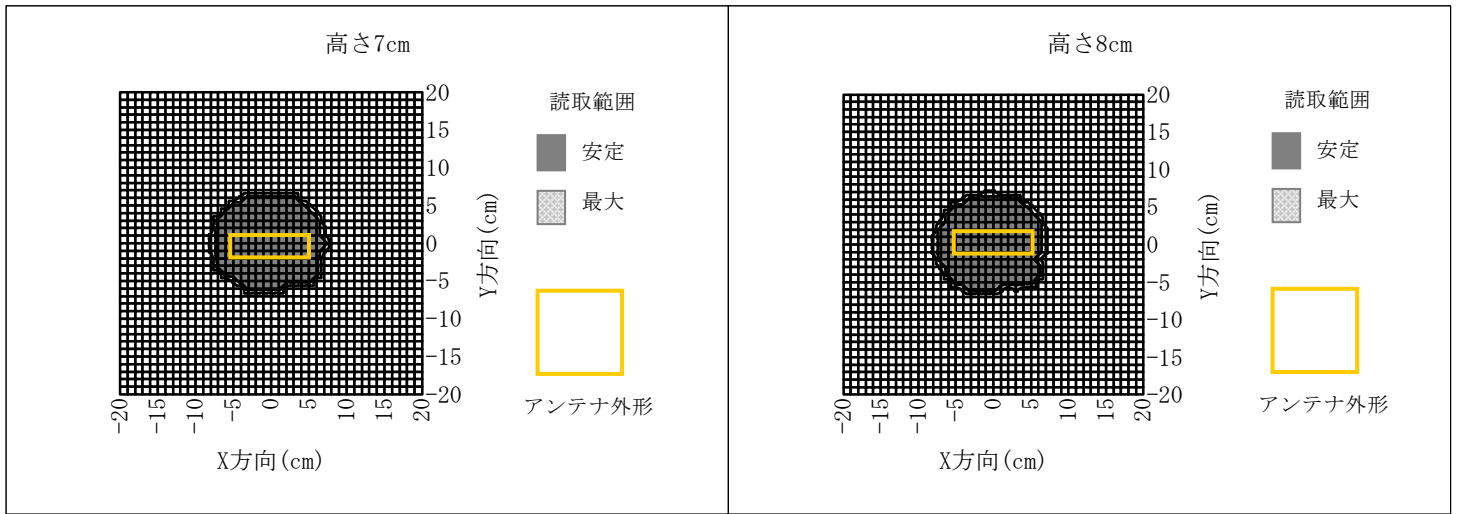

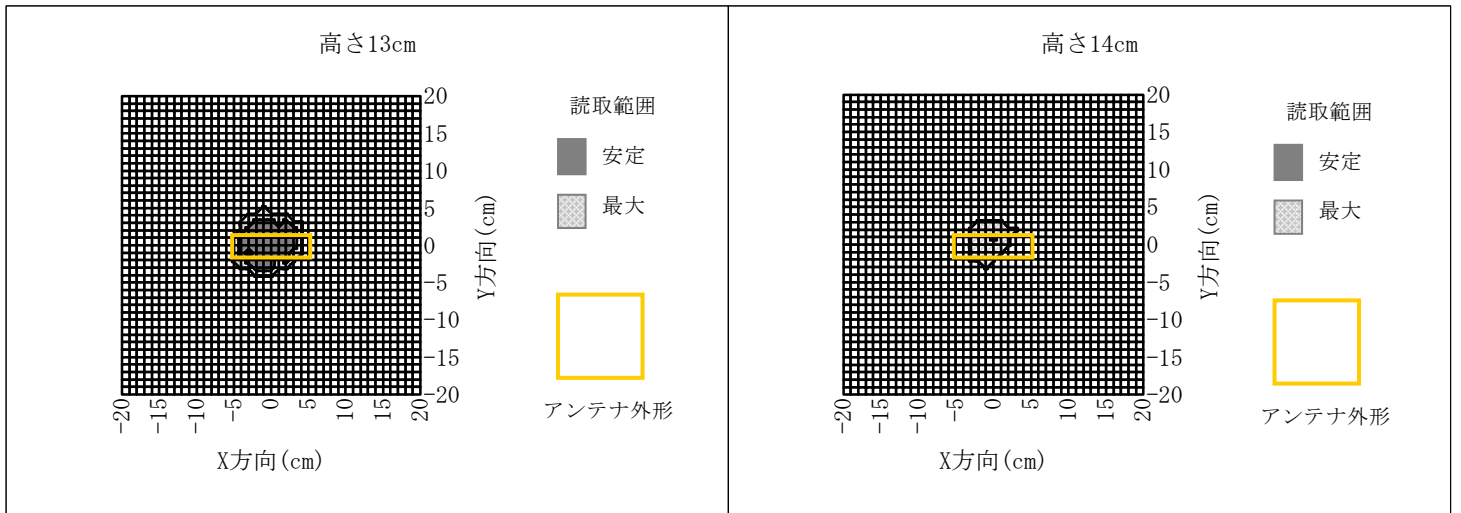

対象アンテナ : TR3-A401(外形 : 15×30mm)
 ICタグ : カードサイズ(Tag-it HF-I)
 交信距離 : MAX 13cm

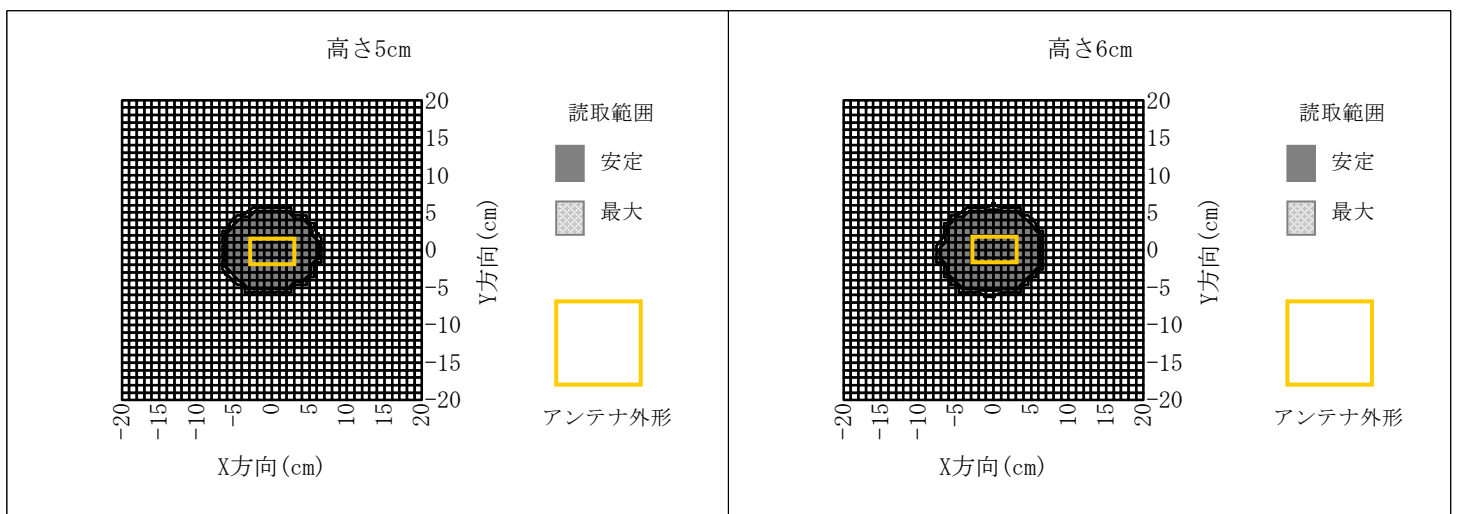
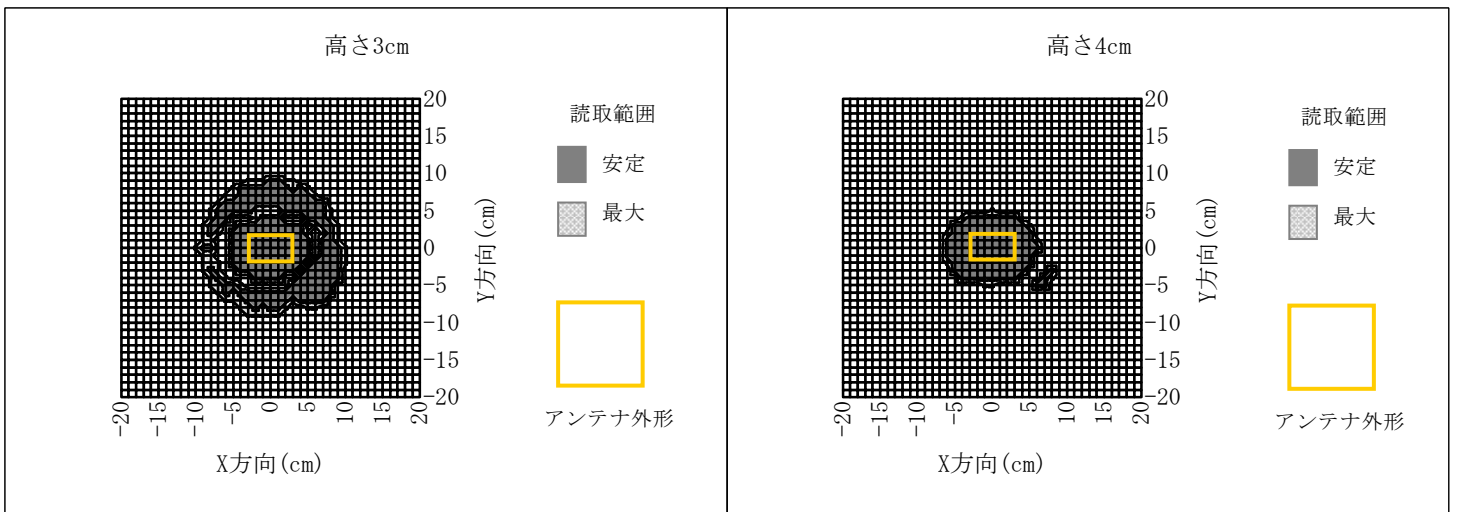
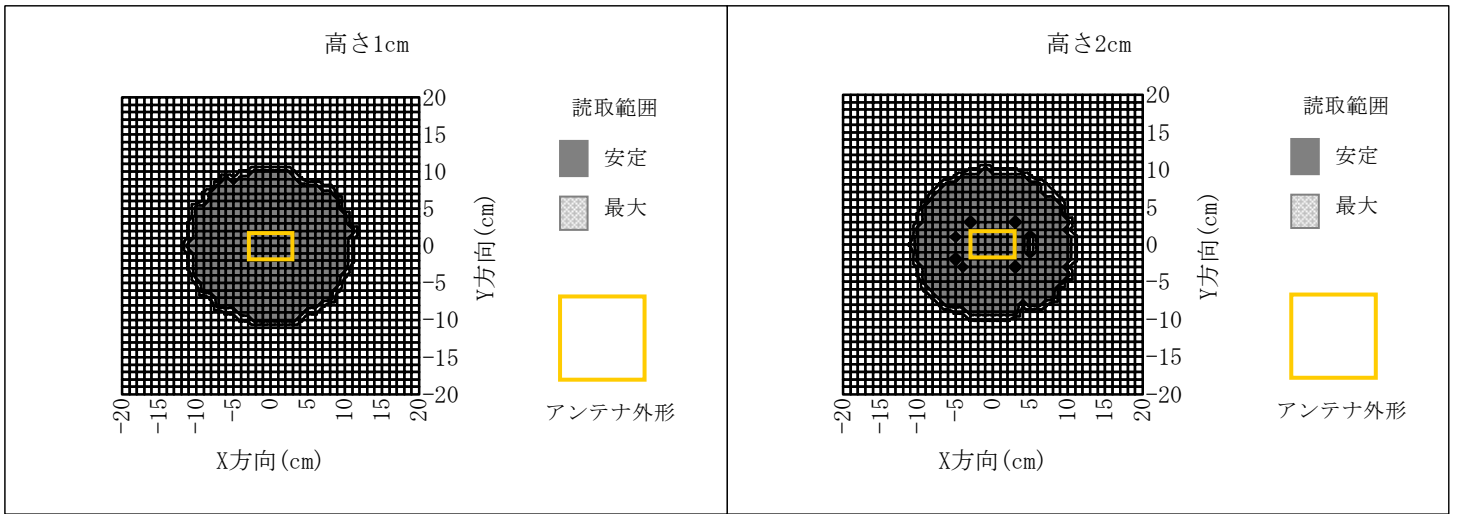

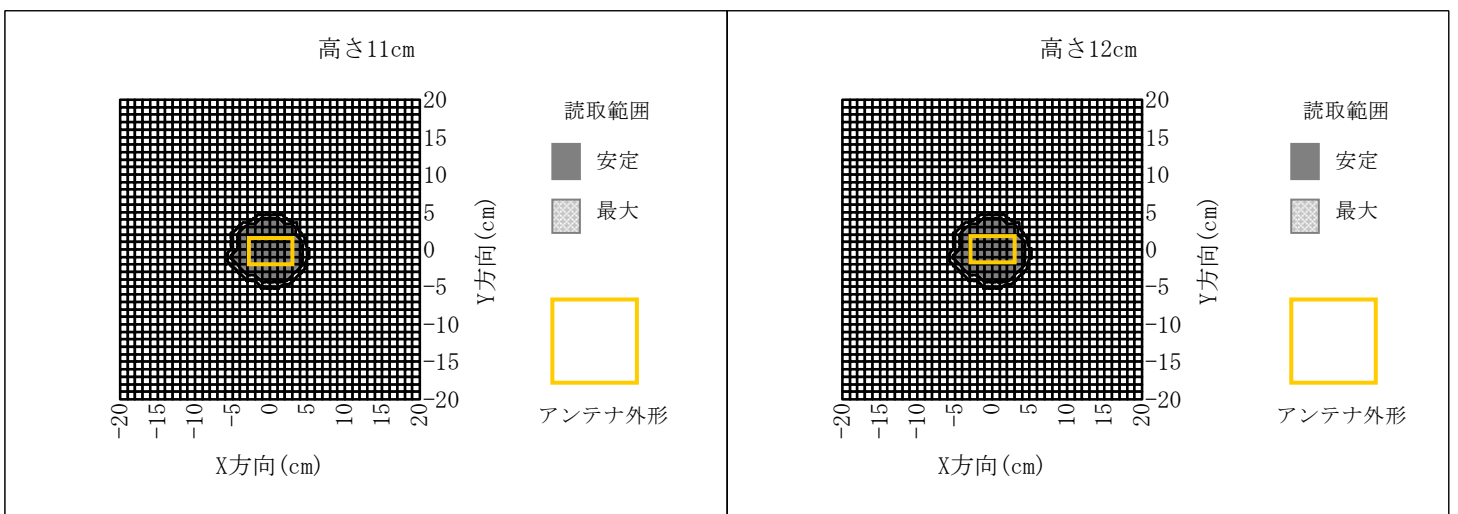
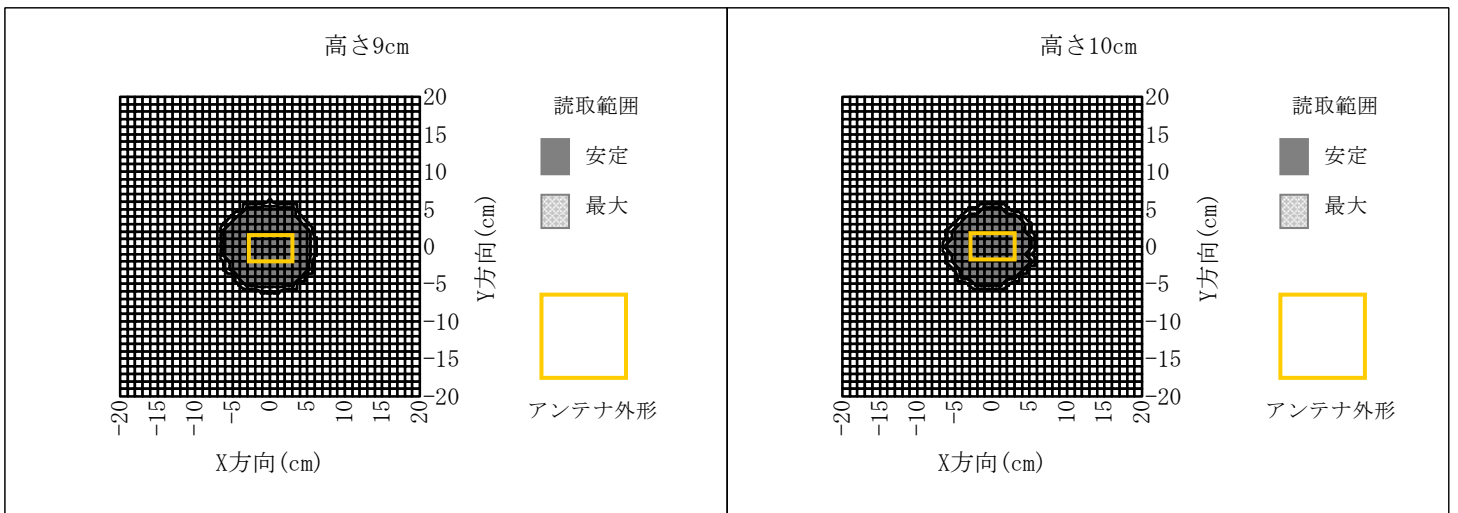
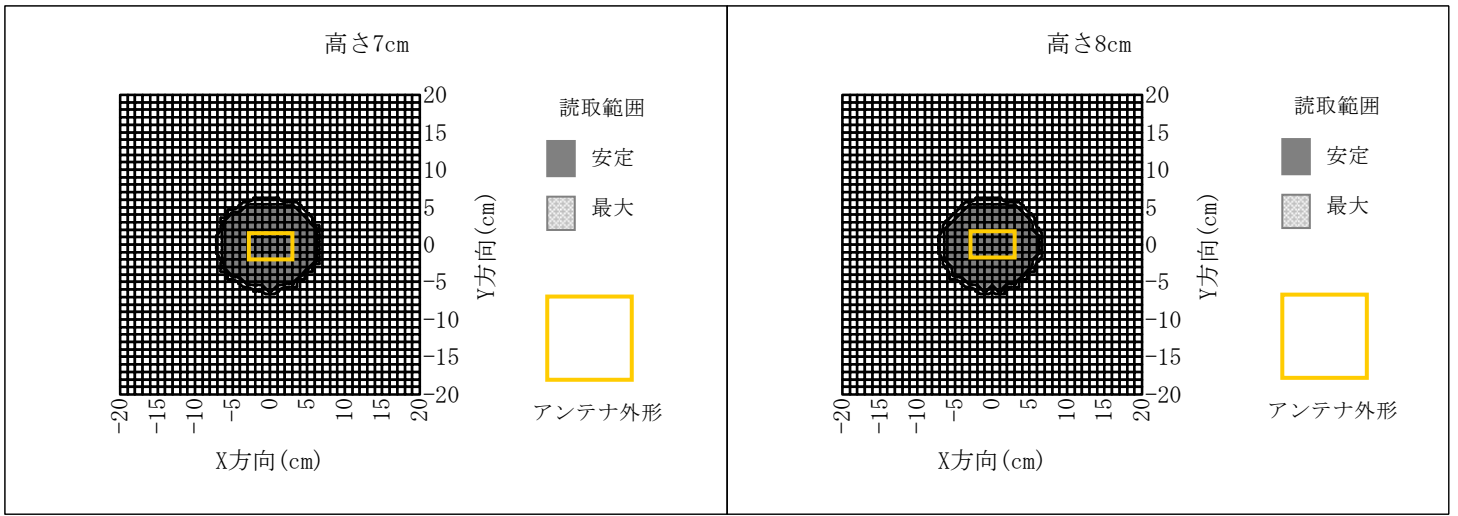

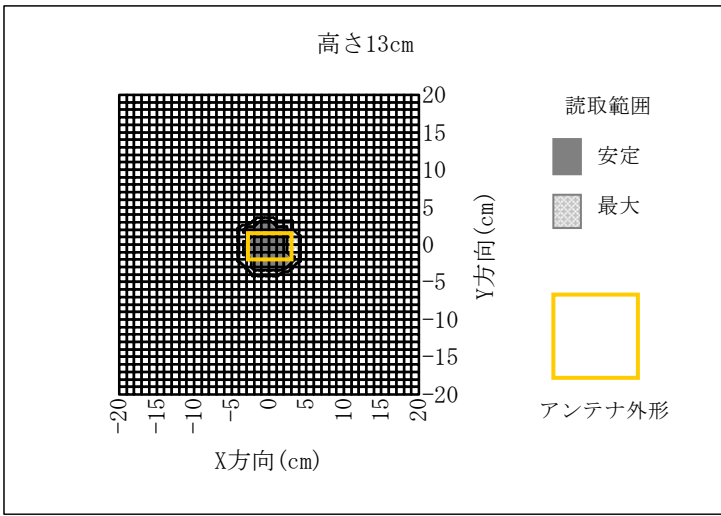

対象アンテナ : TR3-HA101(外形 : 150mm φ)
 ICタグ : カードサイズ(Tag-it HF-I)
 交信距離 : MAX 30cm

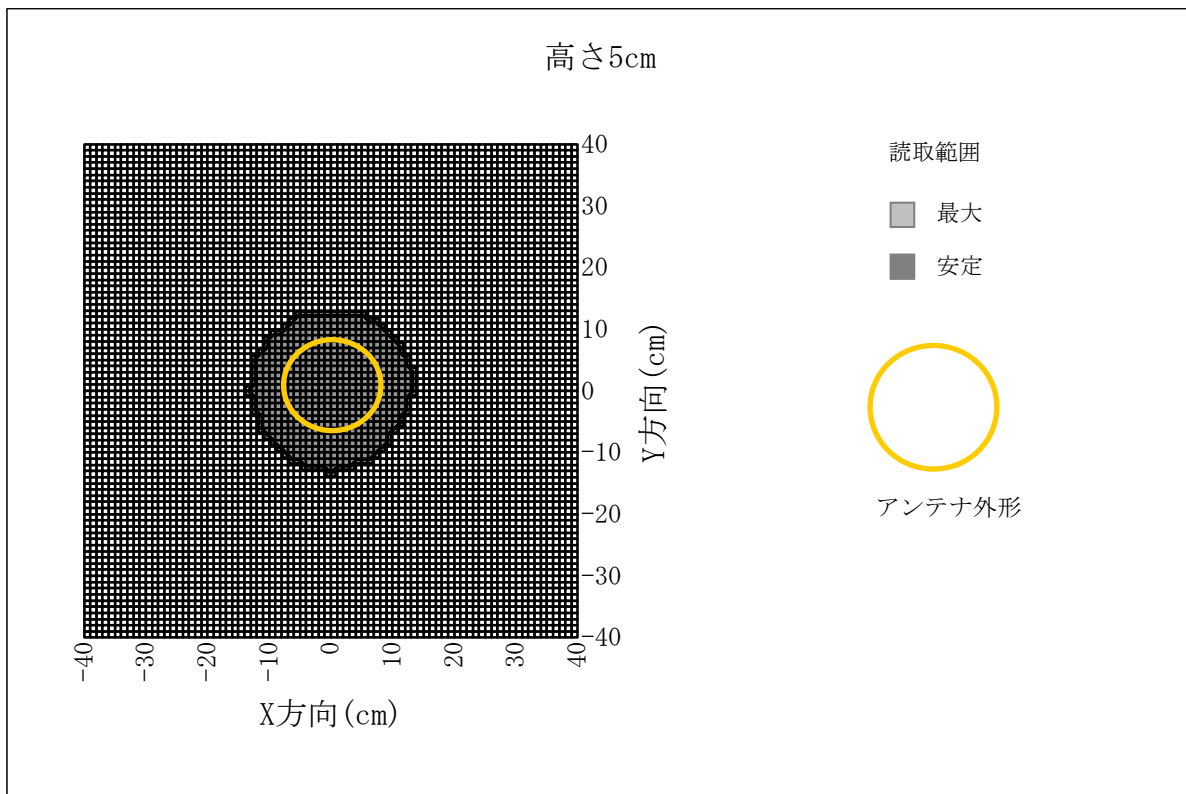
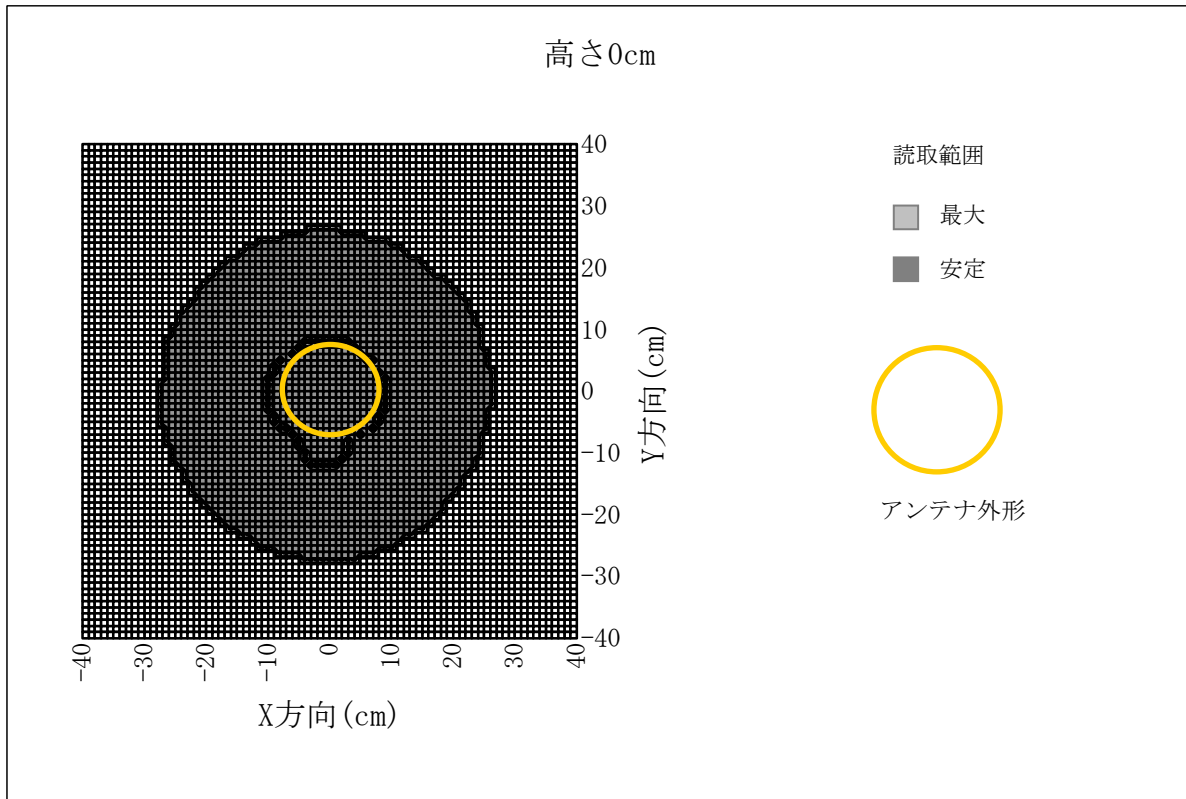

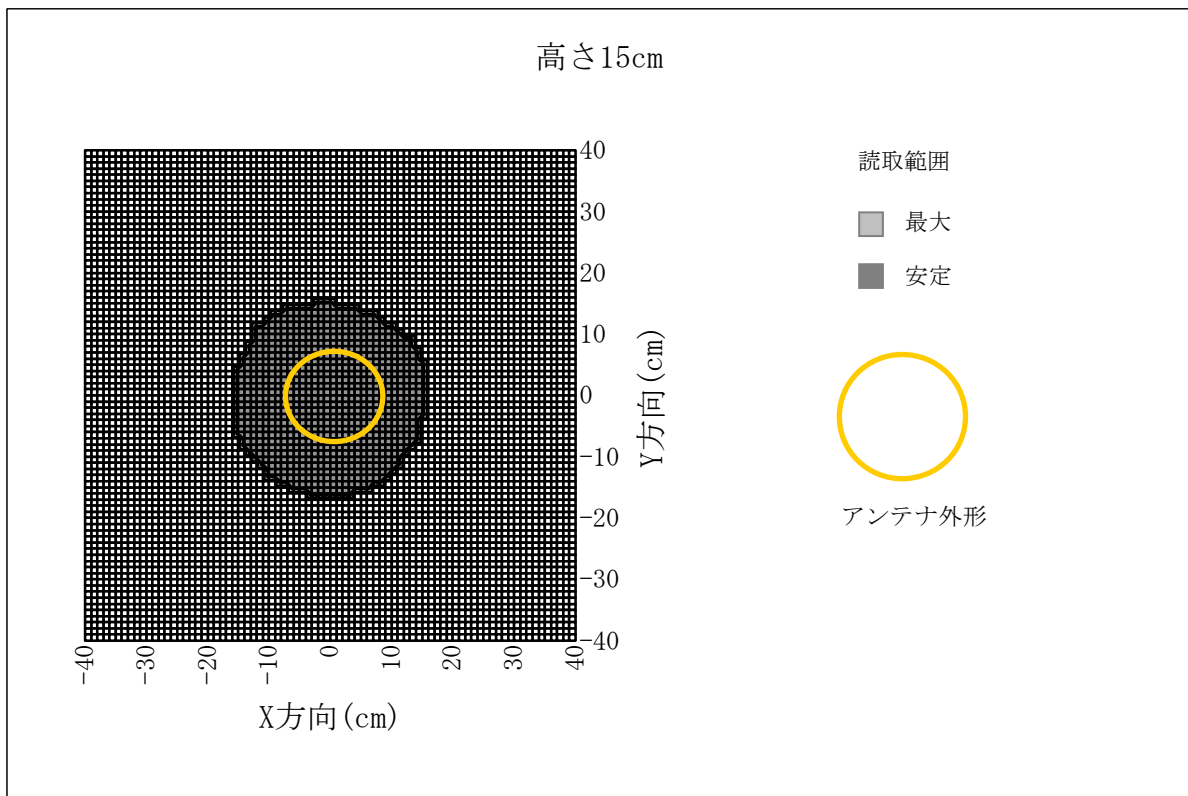
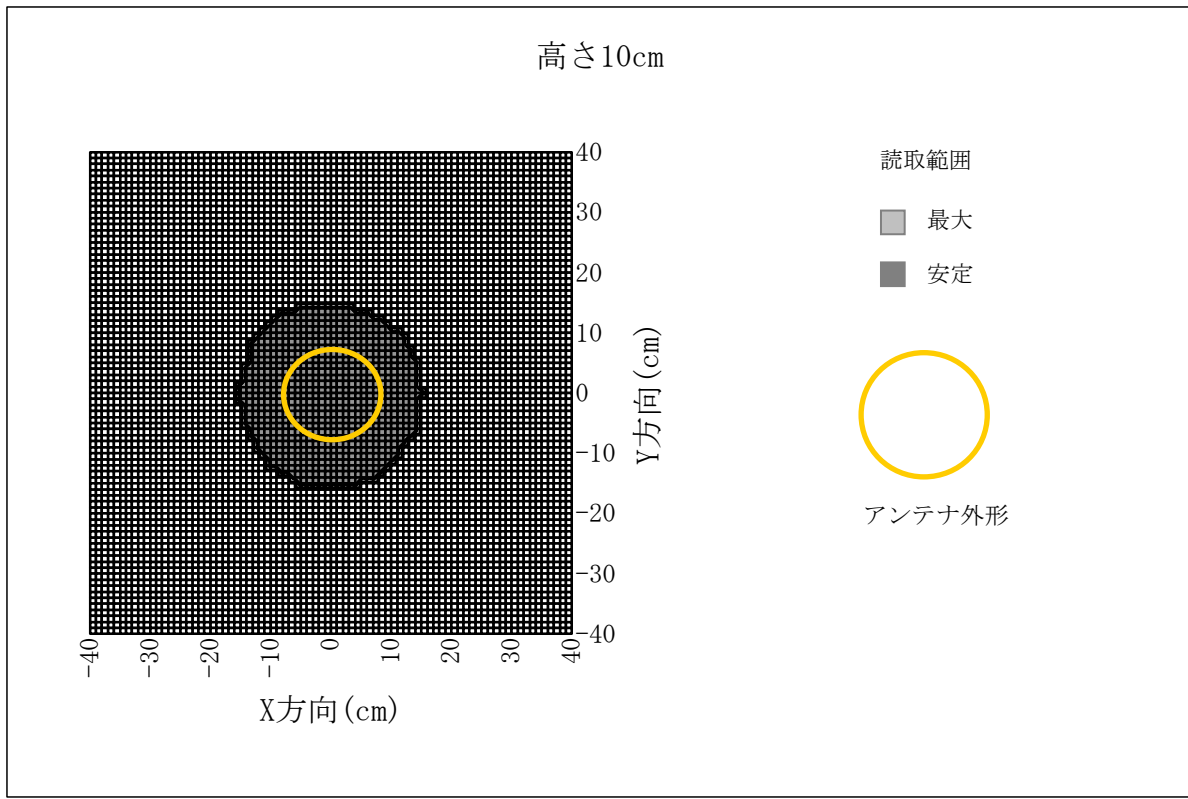

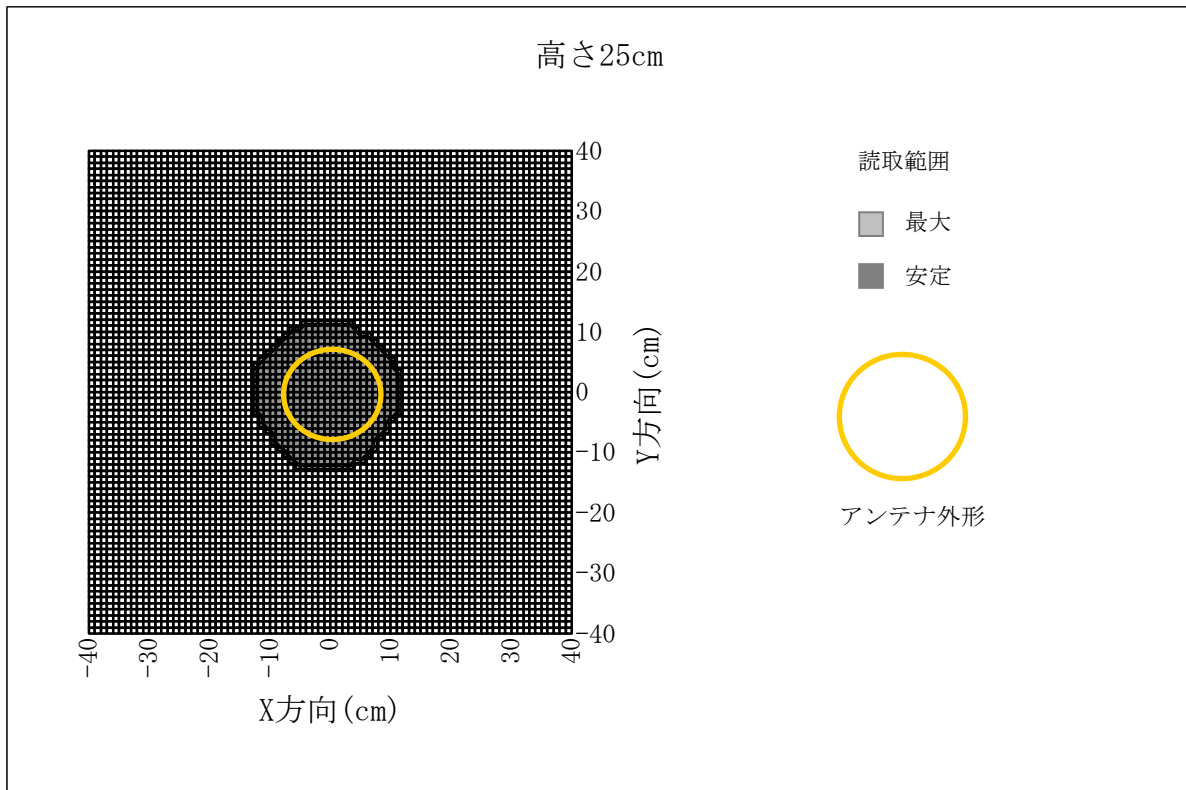
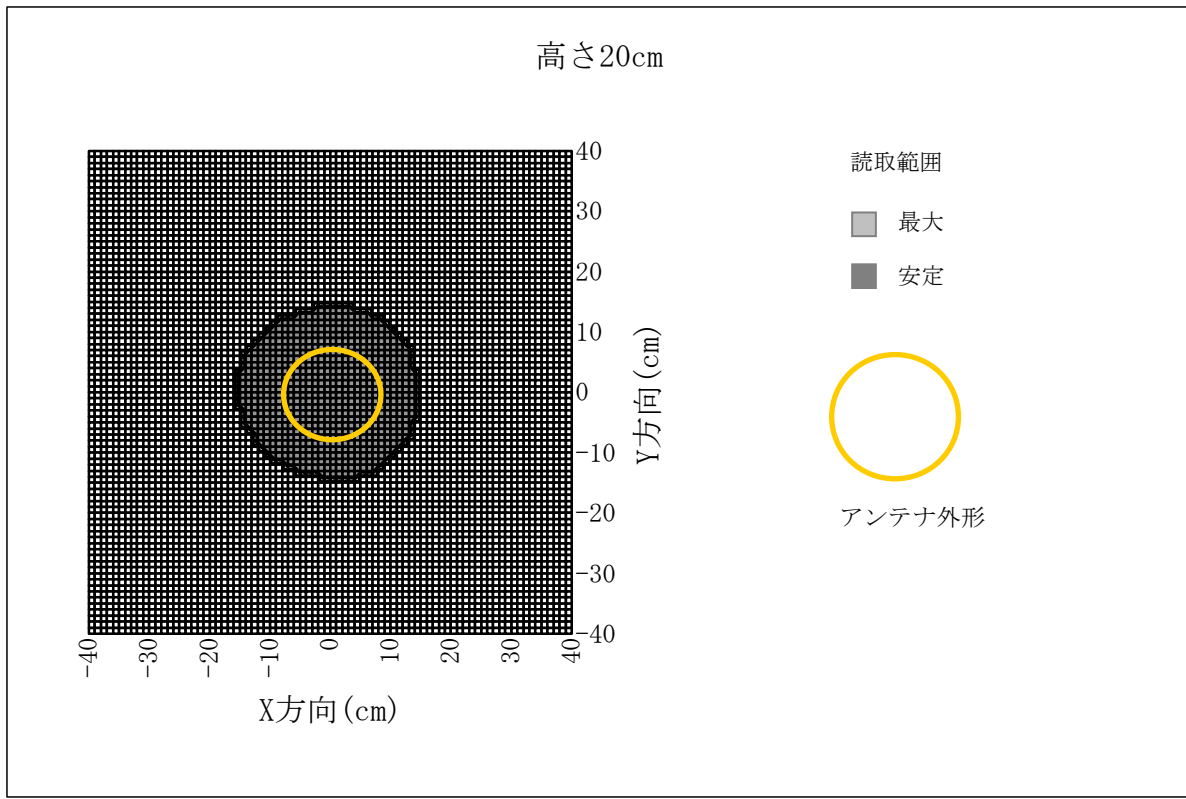

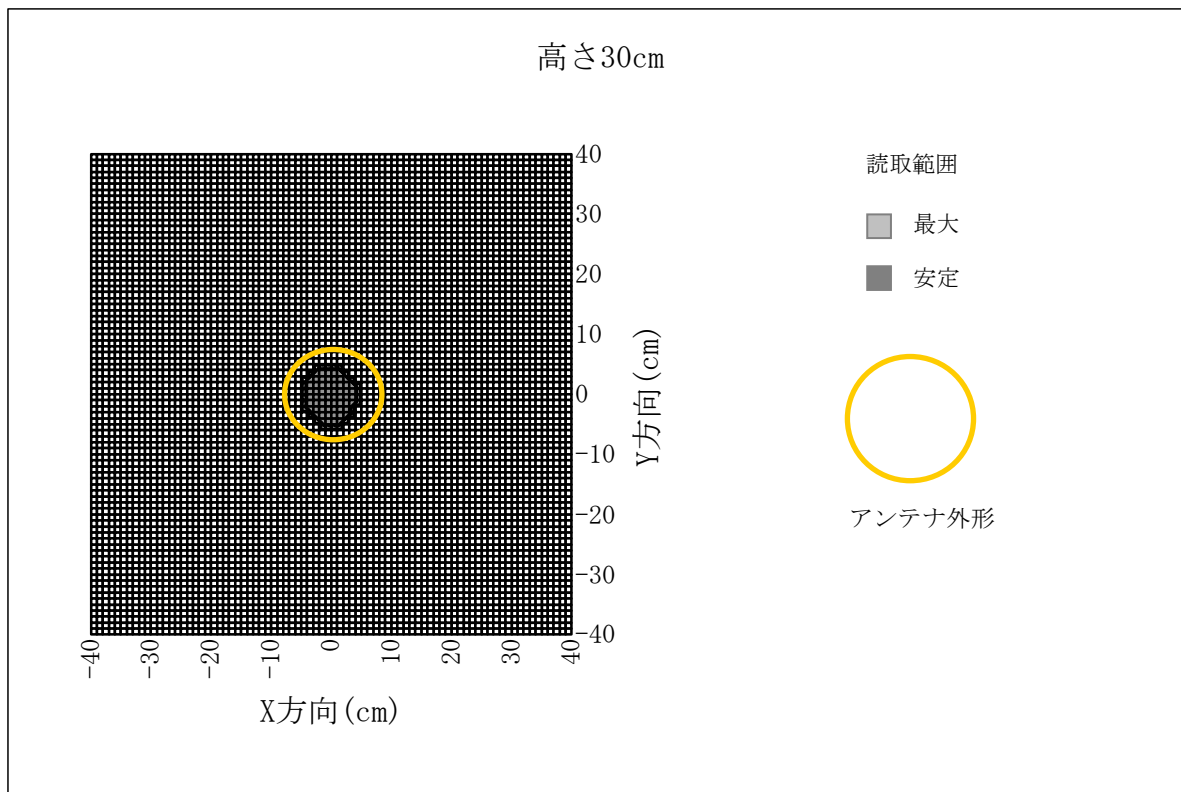

対象アンテナ : TR3-HA201(外形 : 200mm φ)
 ICタグ : カードサイズ(Tag-it HF-I)
 交信距離 : MAX 35cm

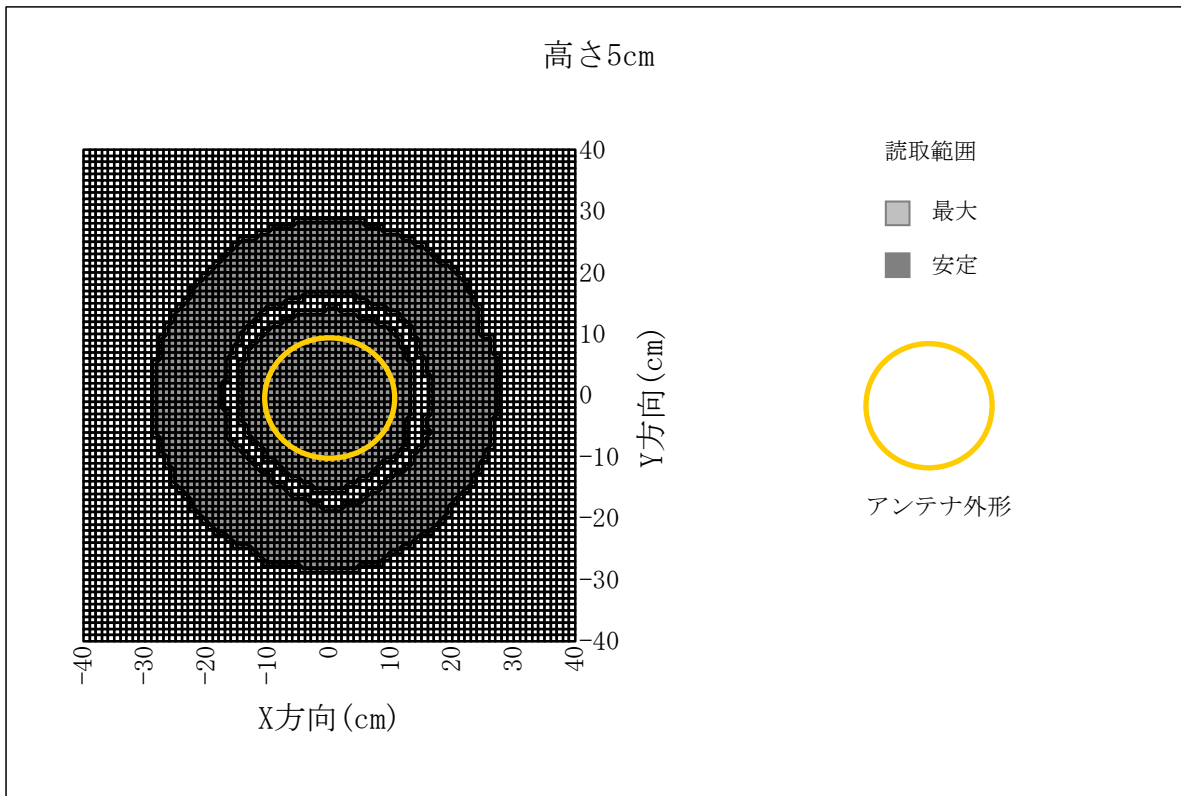
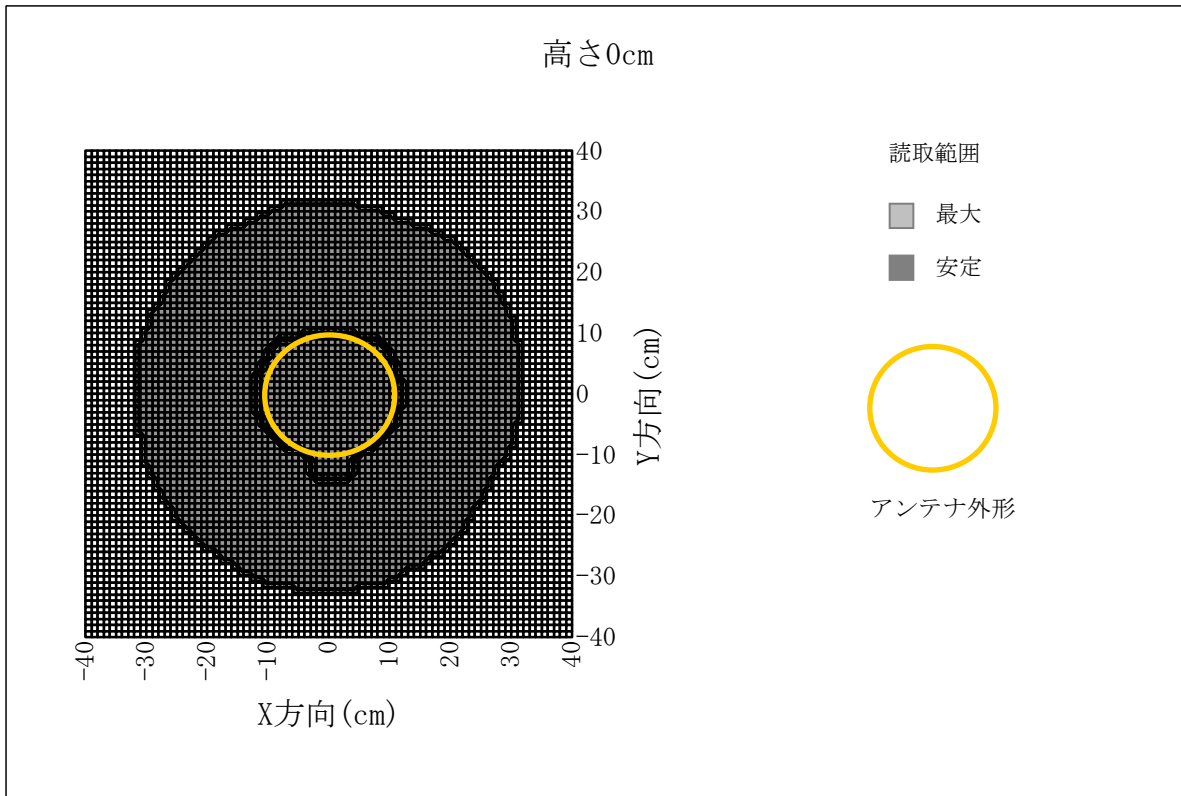

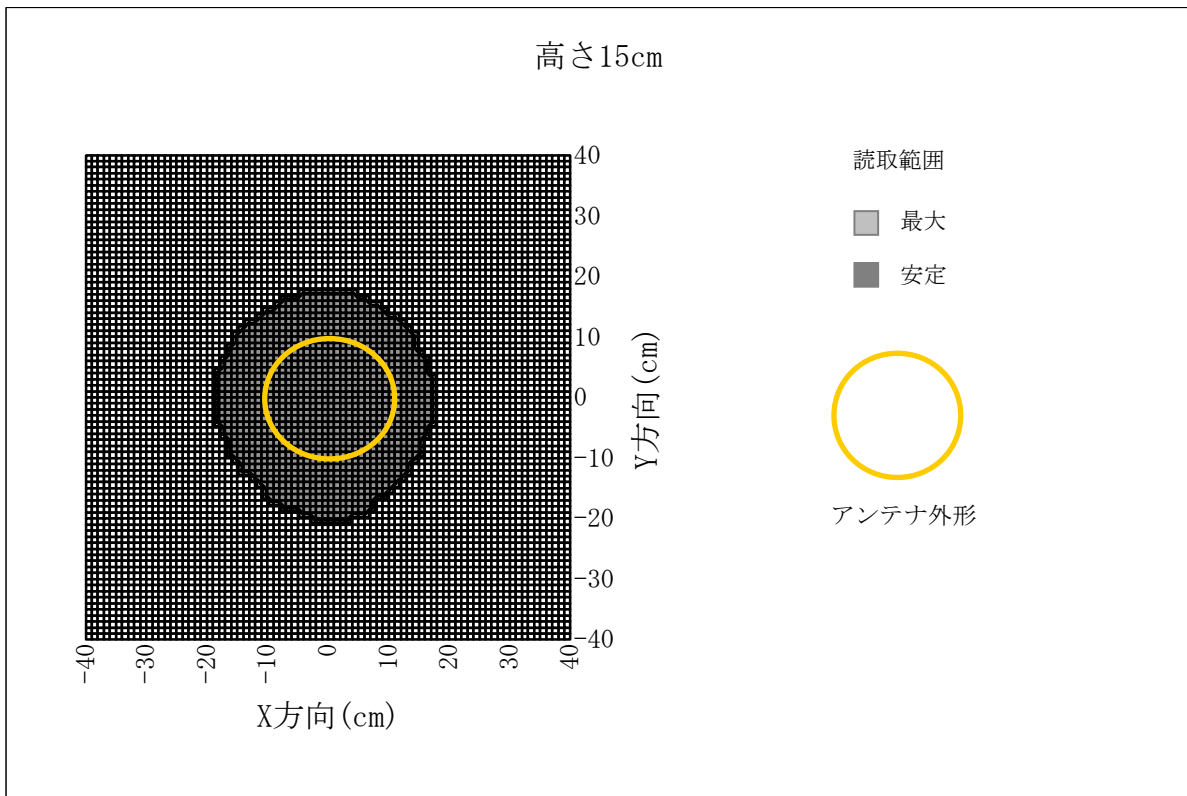
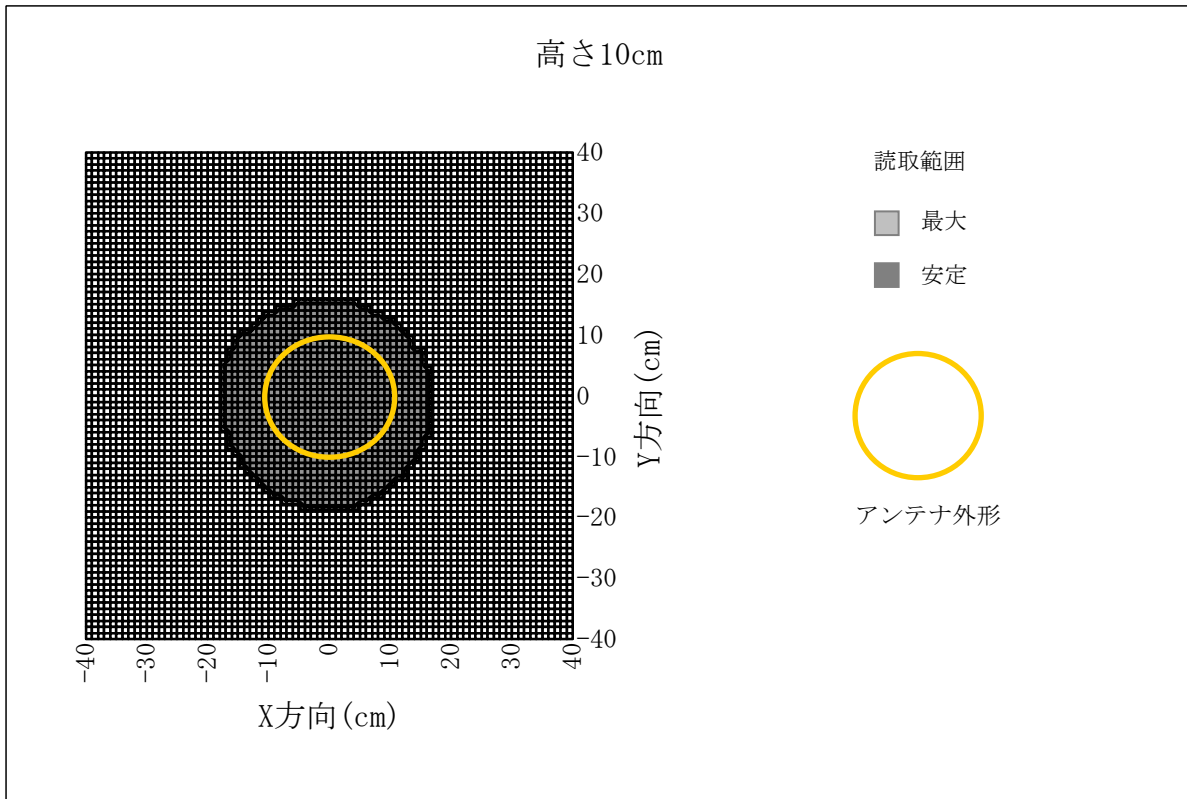

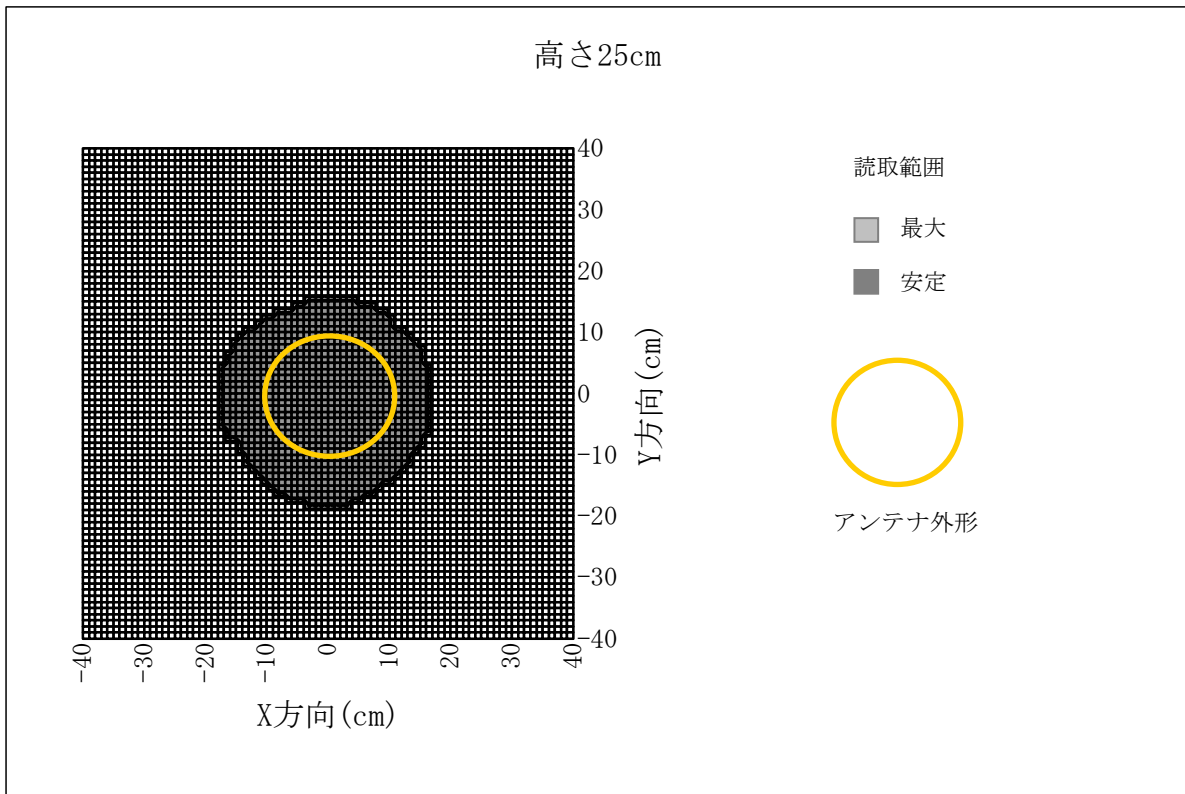
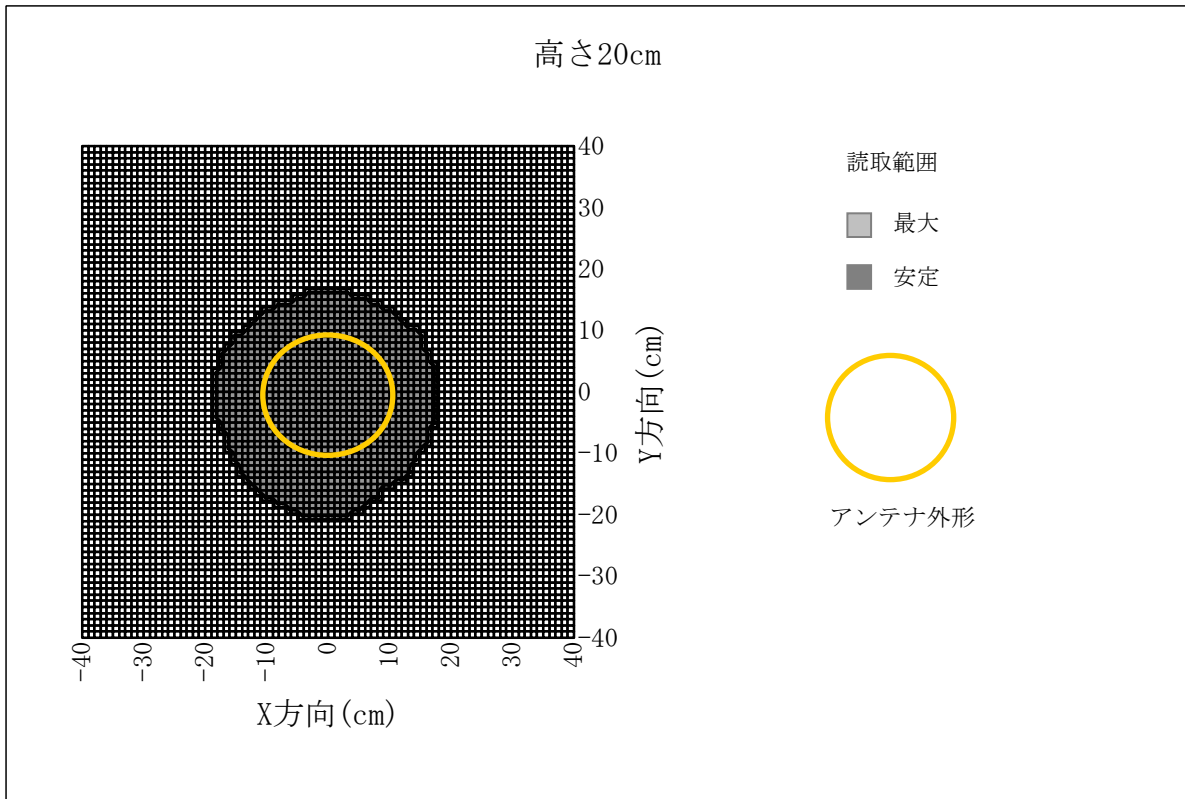

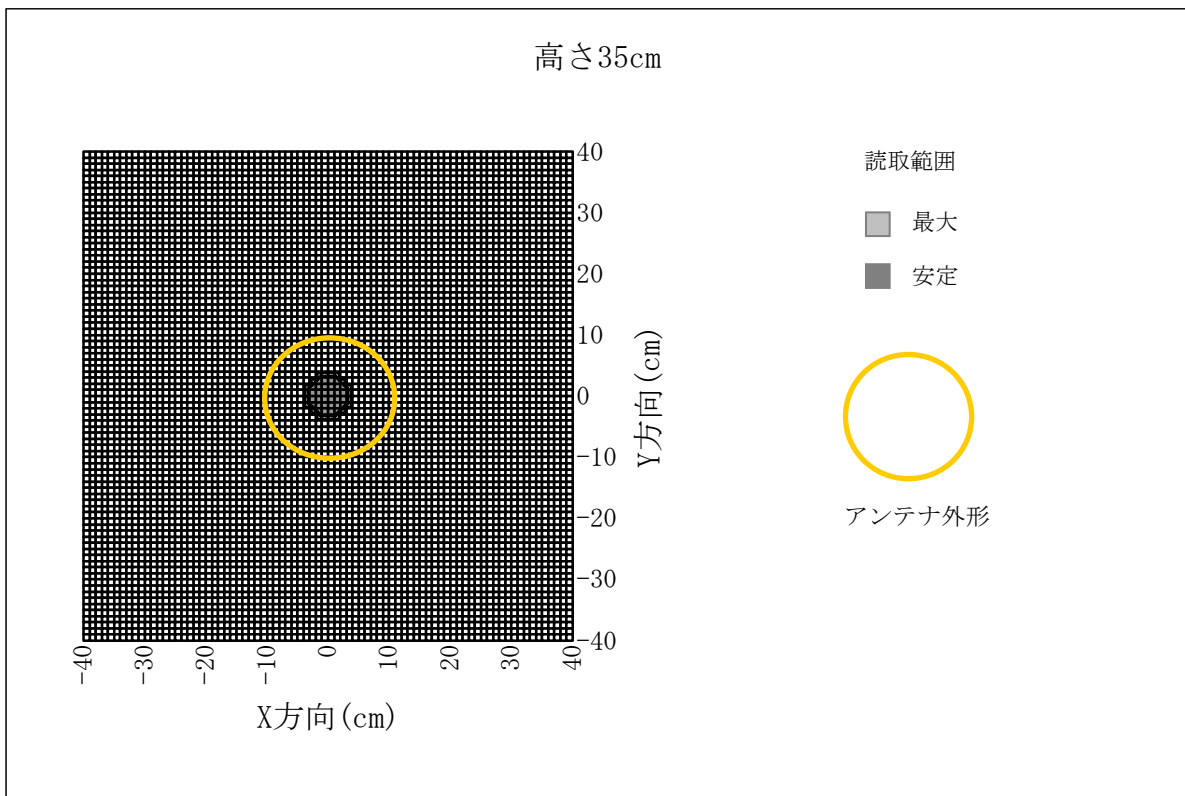
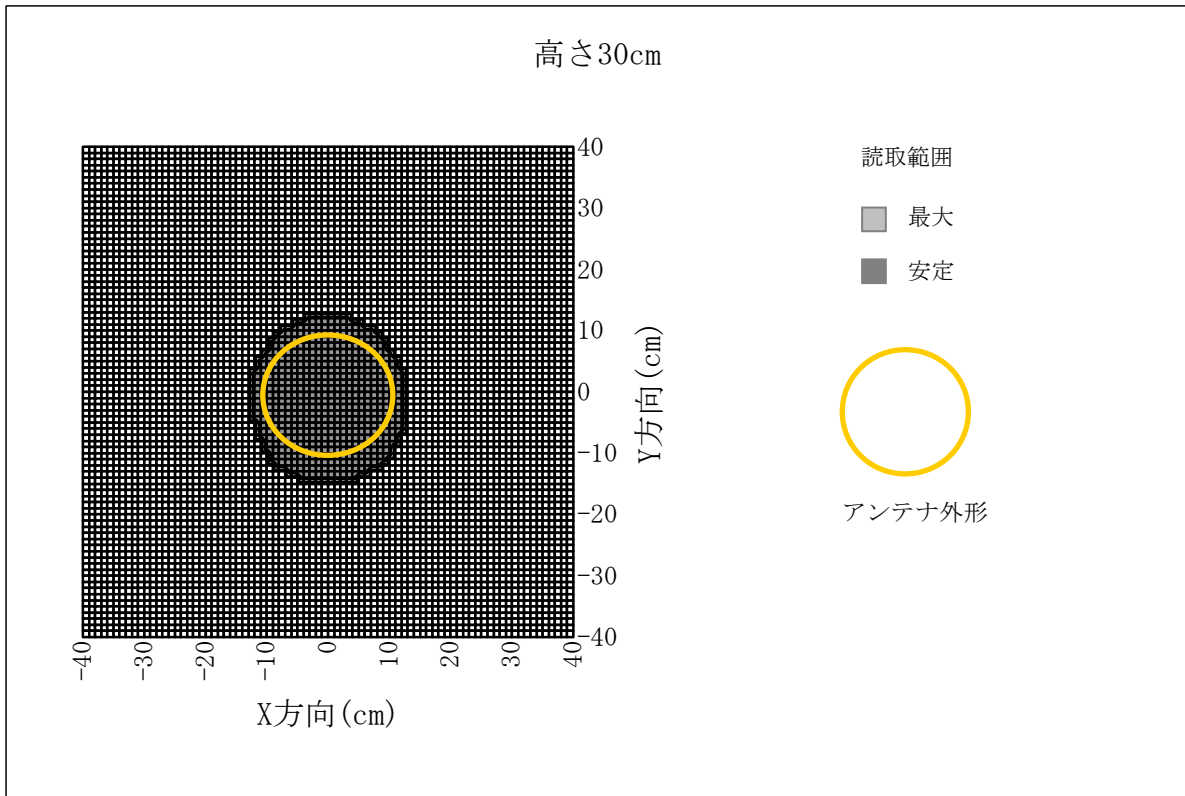

対象アンテナ : TR3-HA301(外形 : 約153×230mm)
 ICタグ : カードサイズ(Tag-it HF-I)
 交信距離 : MAX 30cm

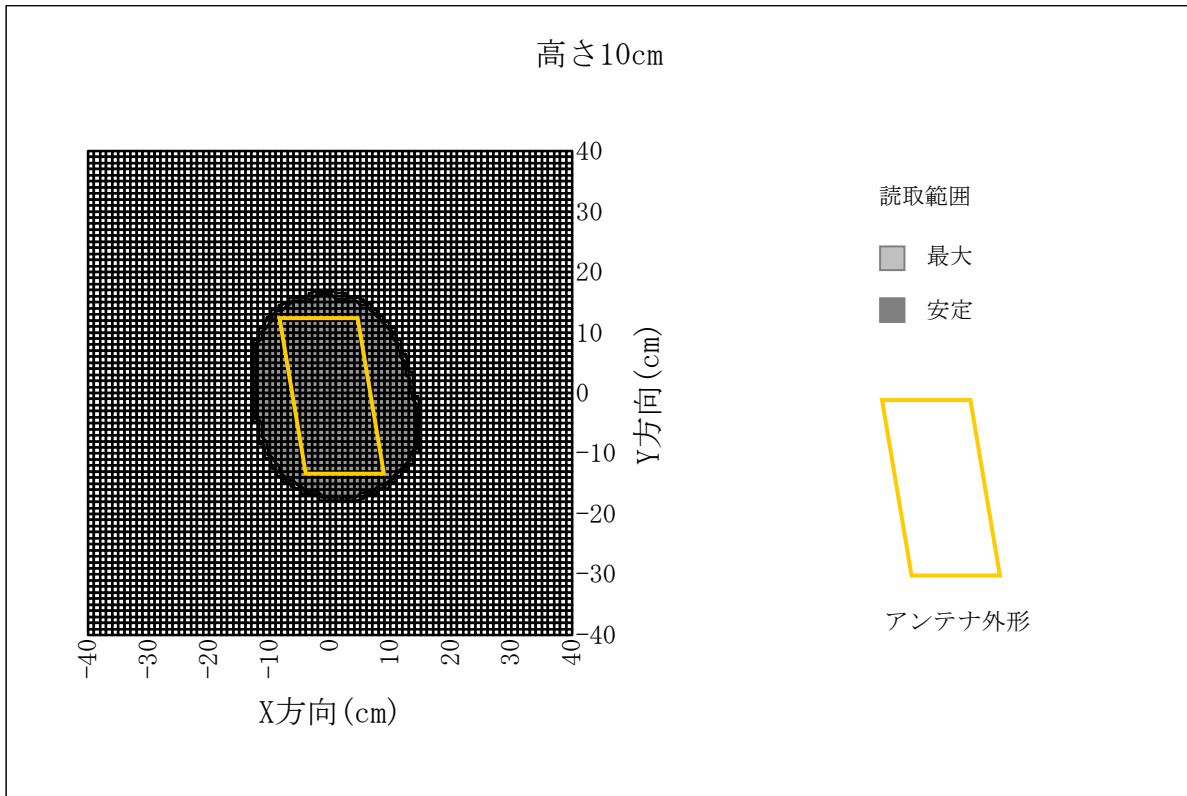
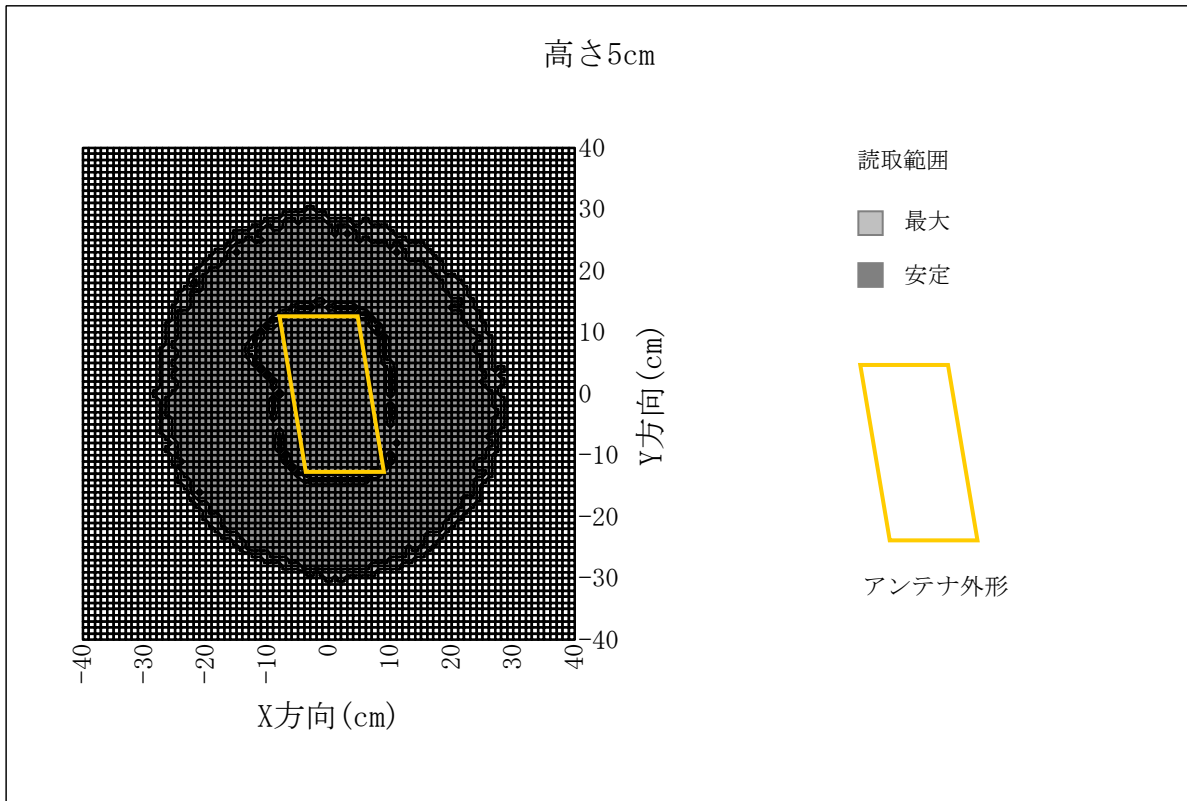

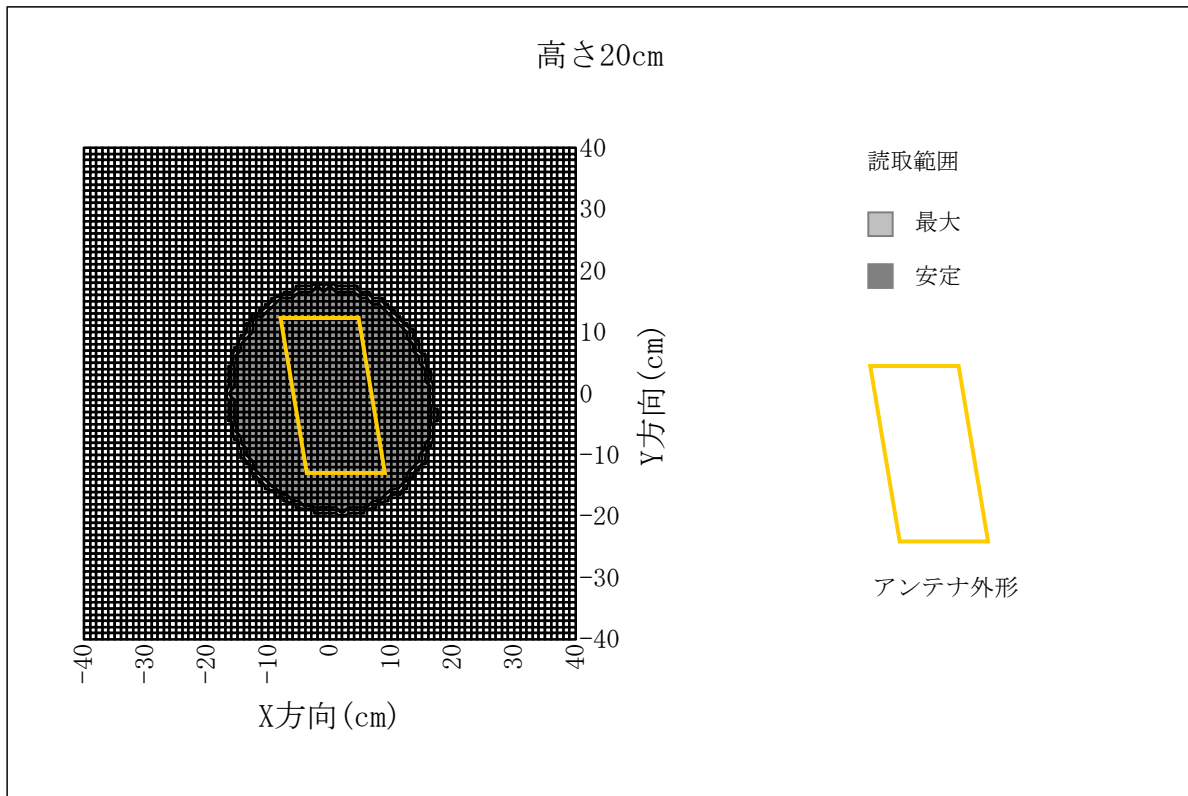
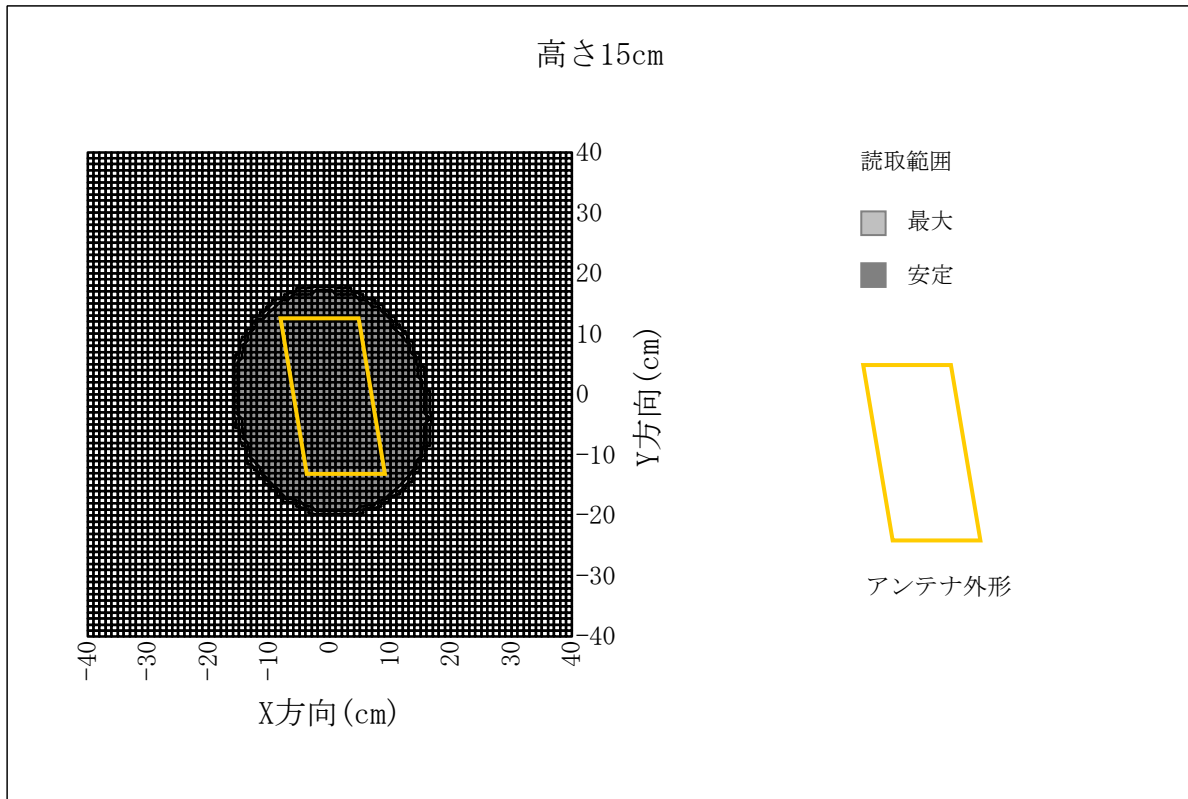

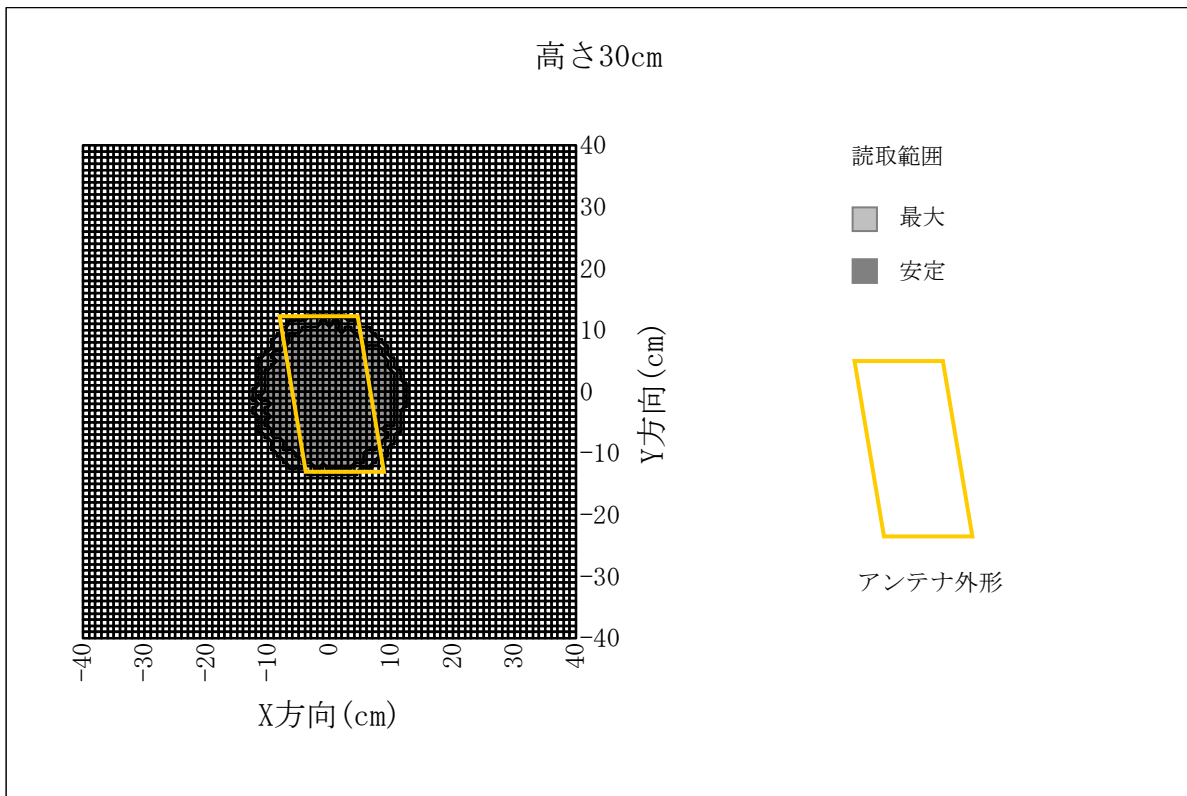
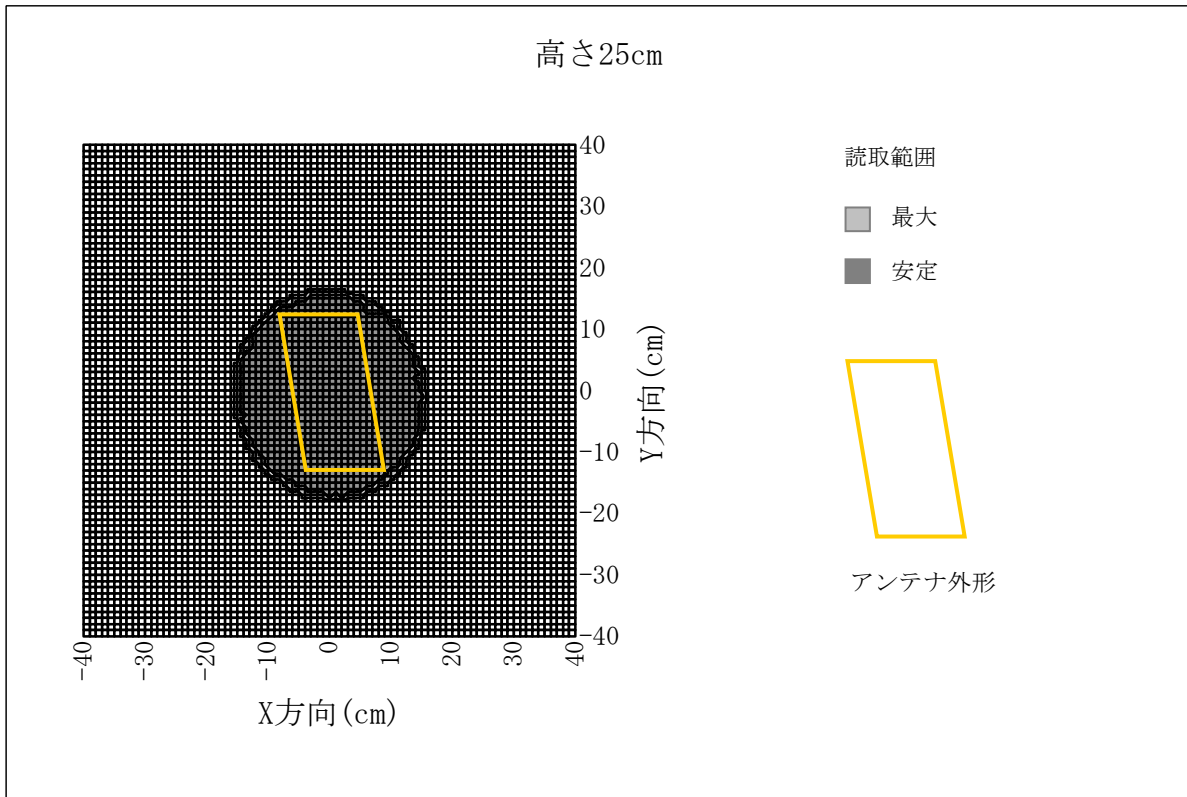

対象アンテナ : TR3-SA101(外形 : 324×254mm)
 ICタグ : カードサイズ(Tag-it HF-I)
 交信距離 : MAX 42cm

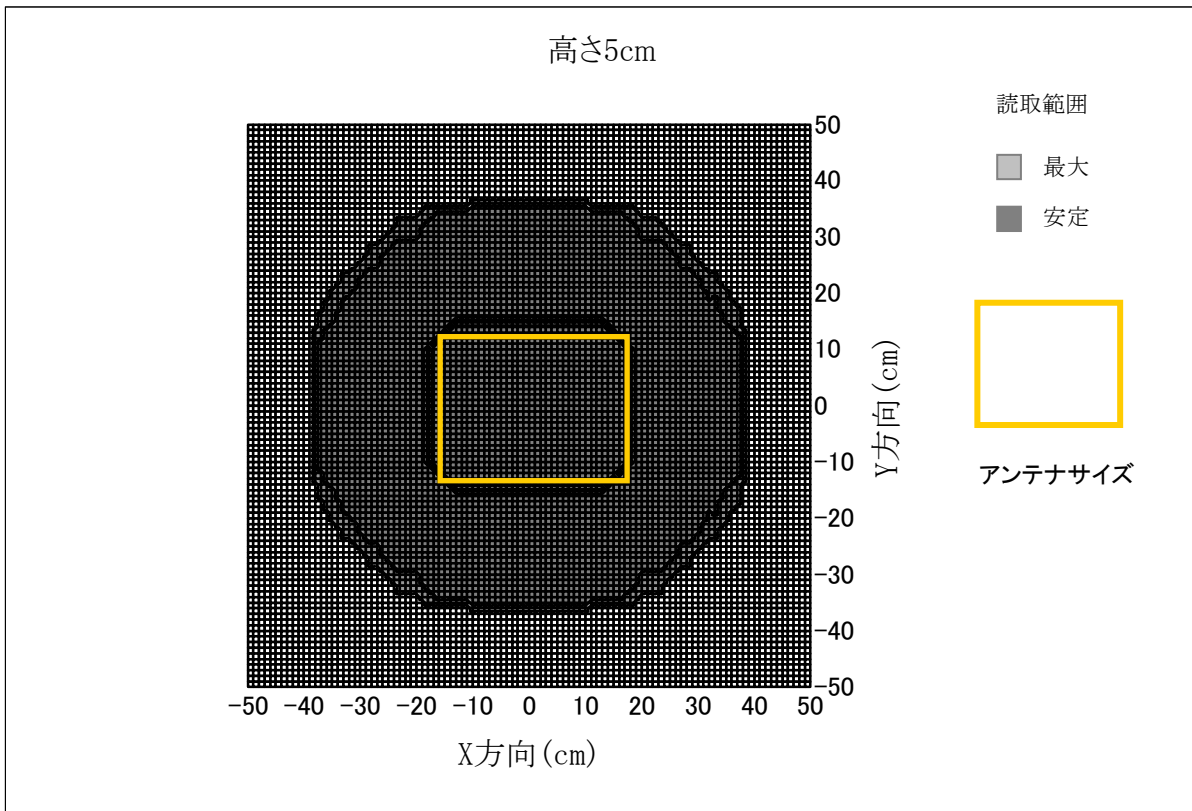
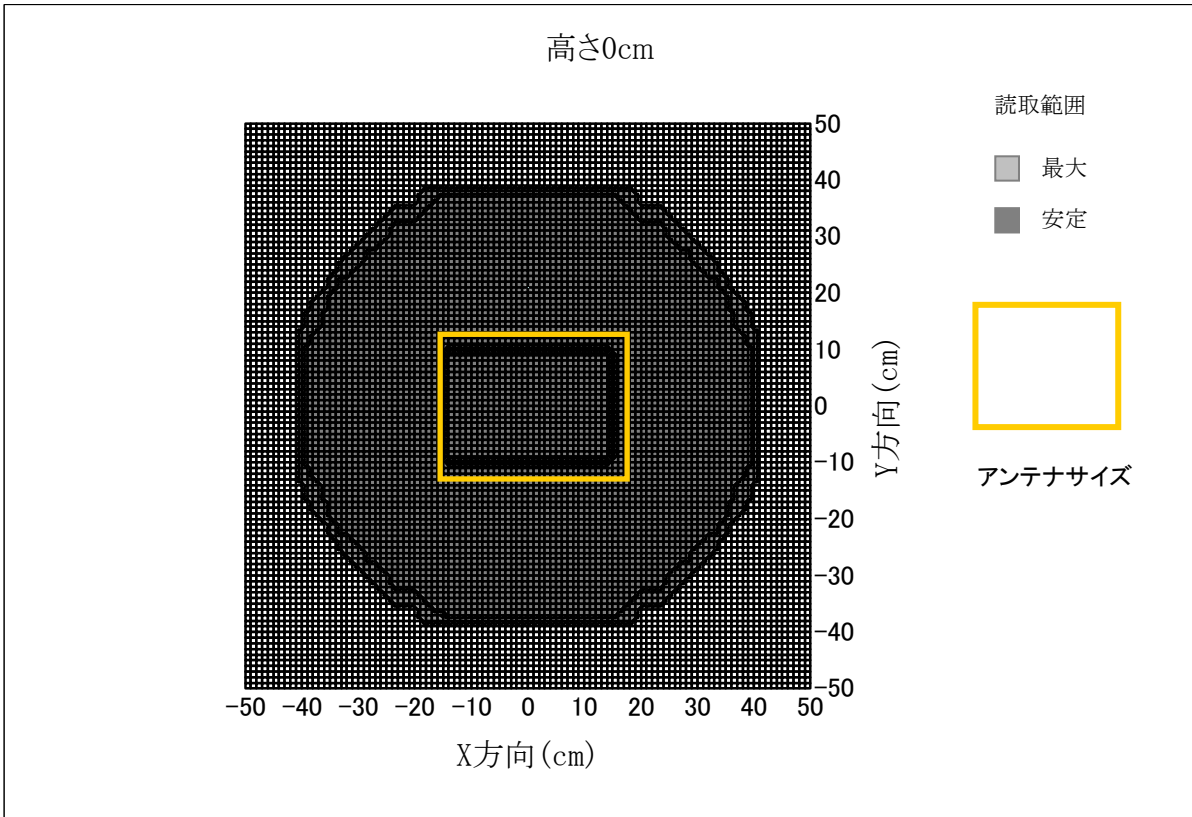

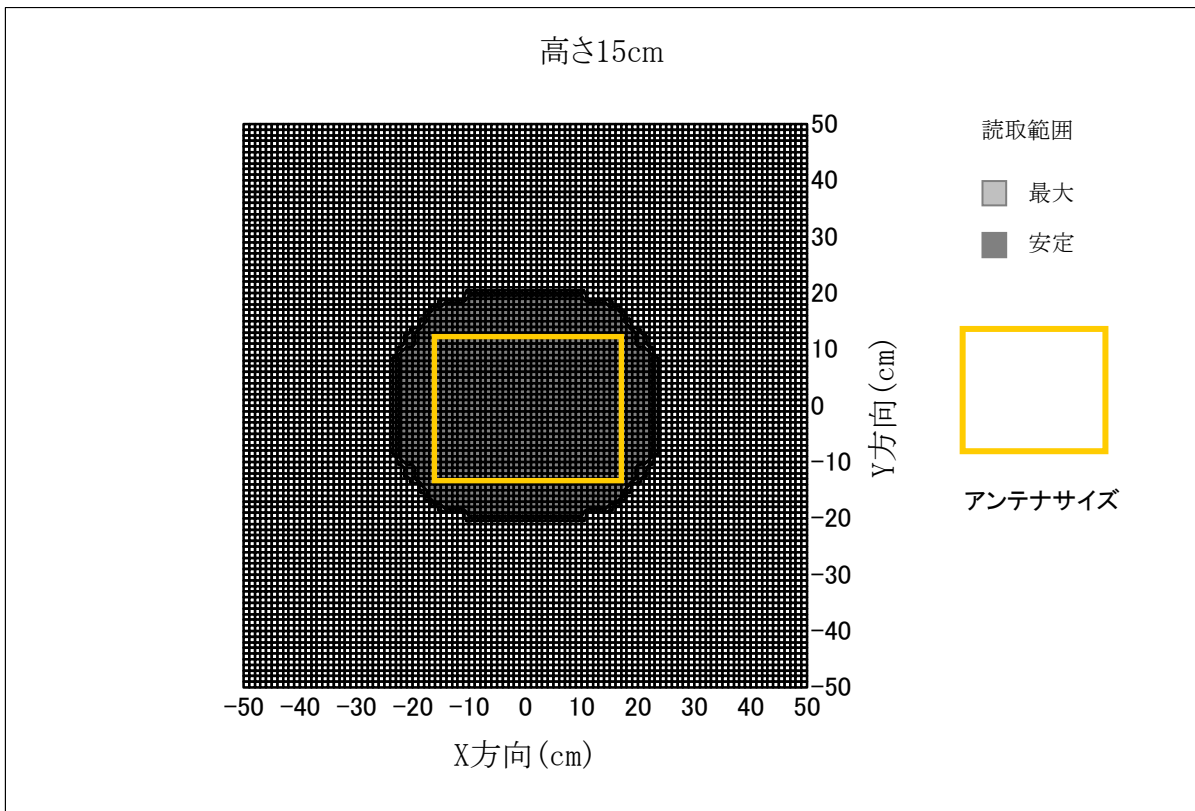
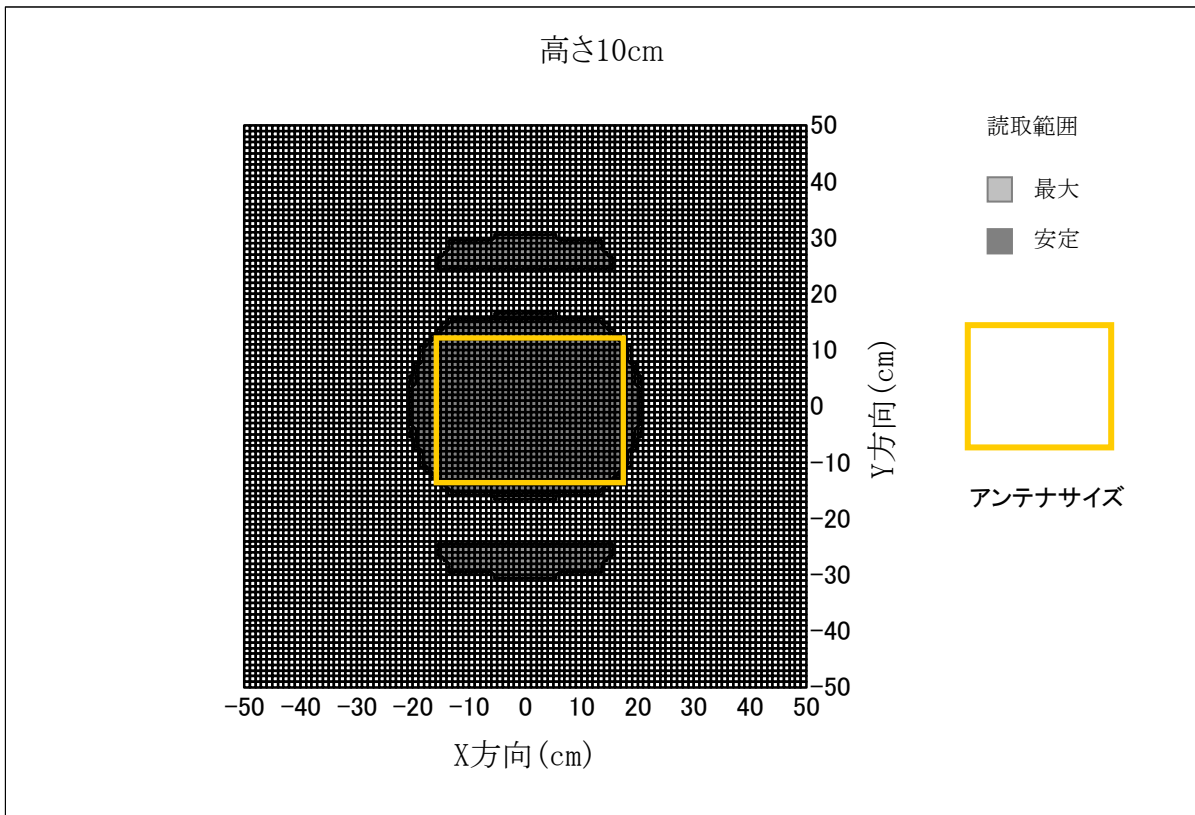

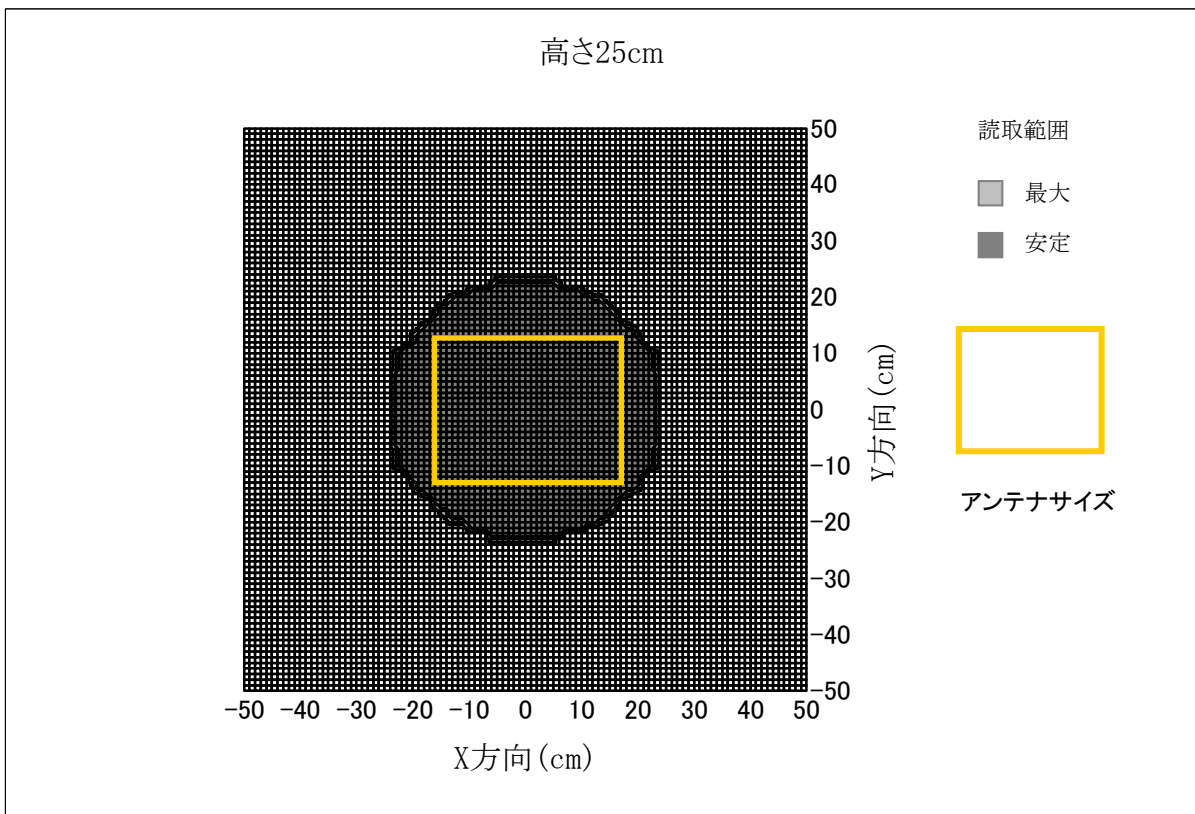
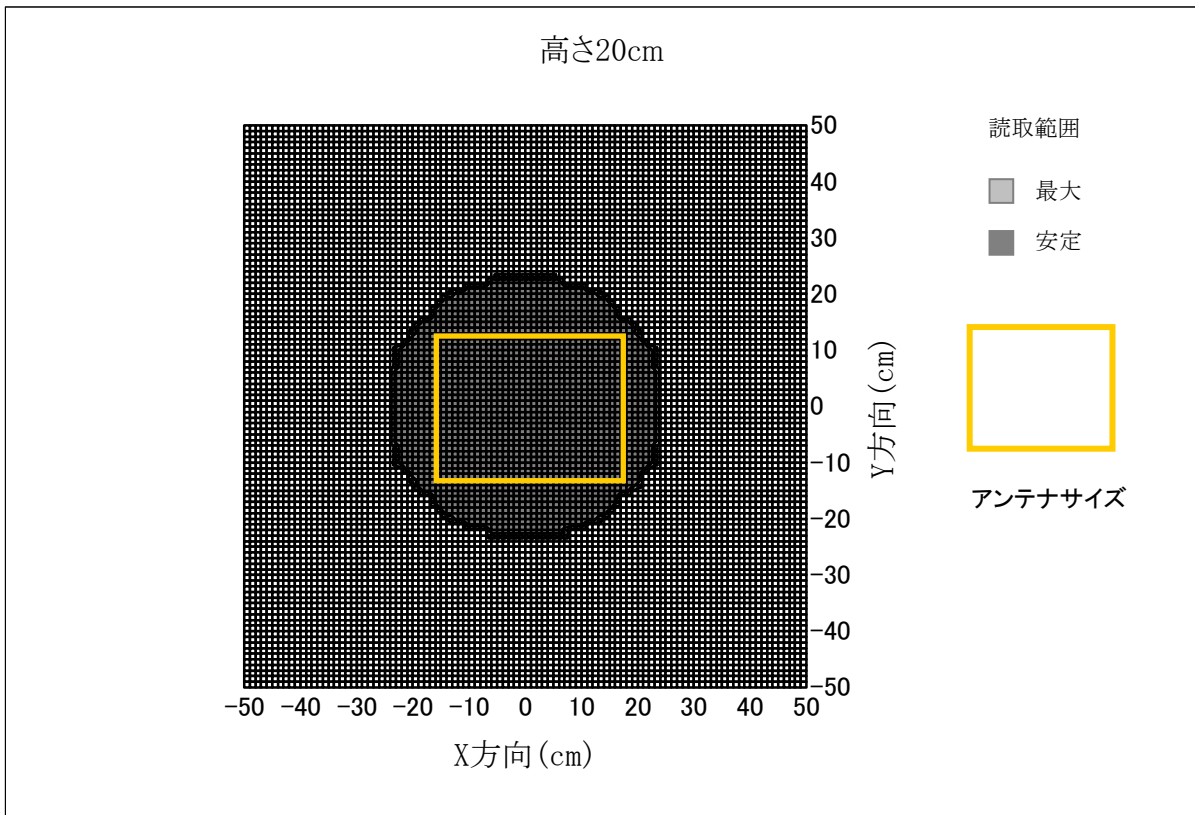

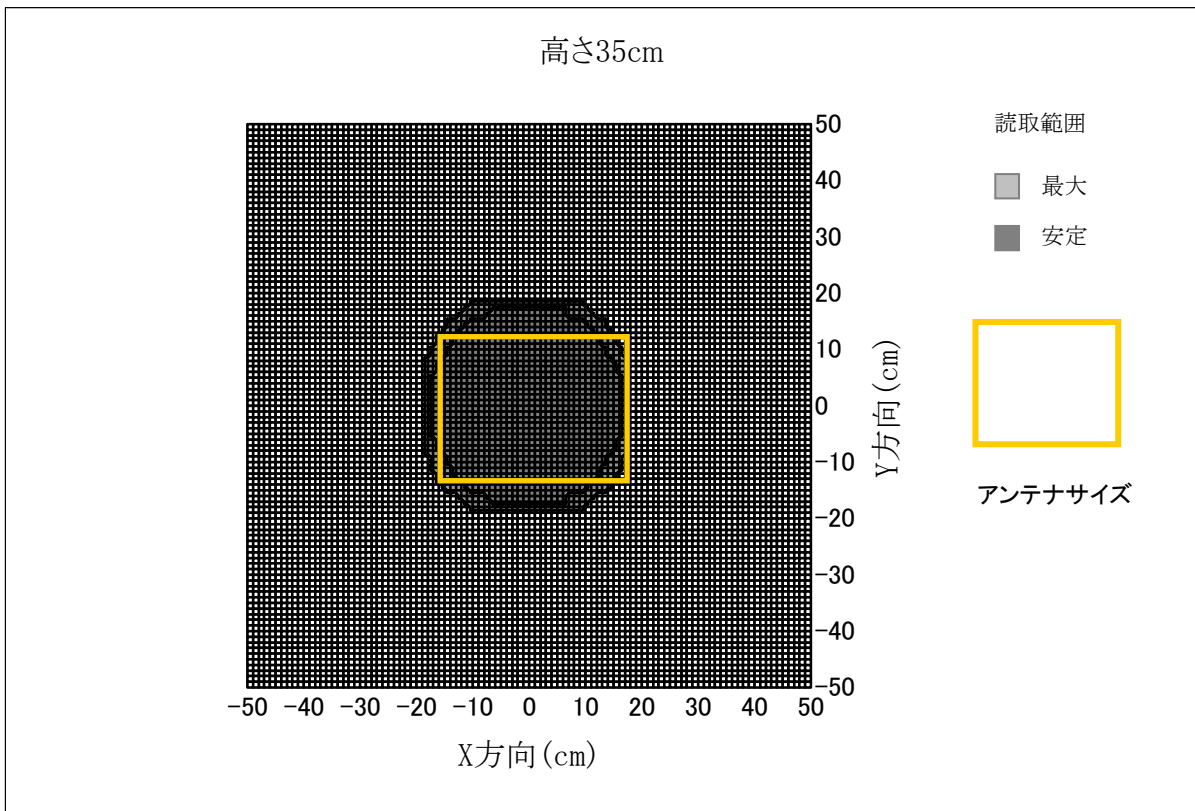
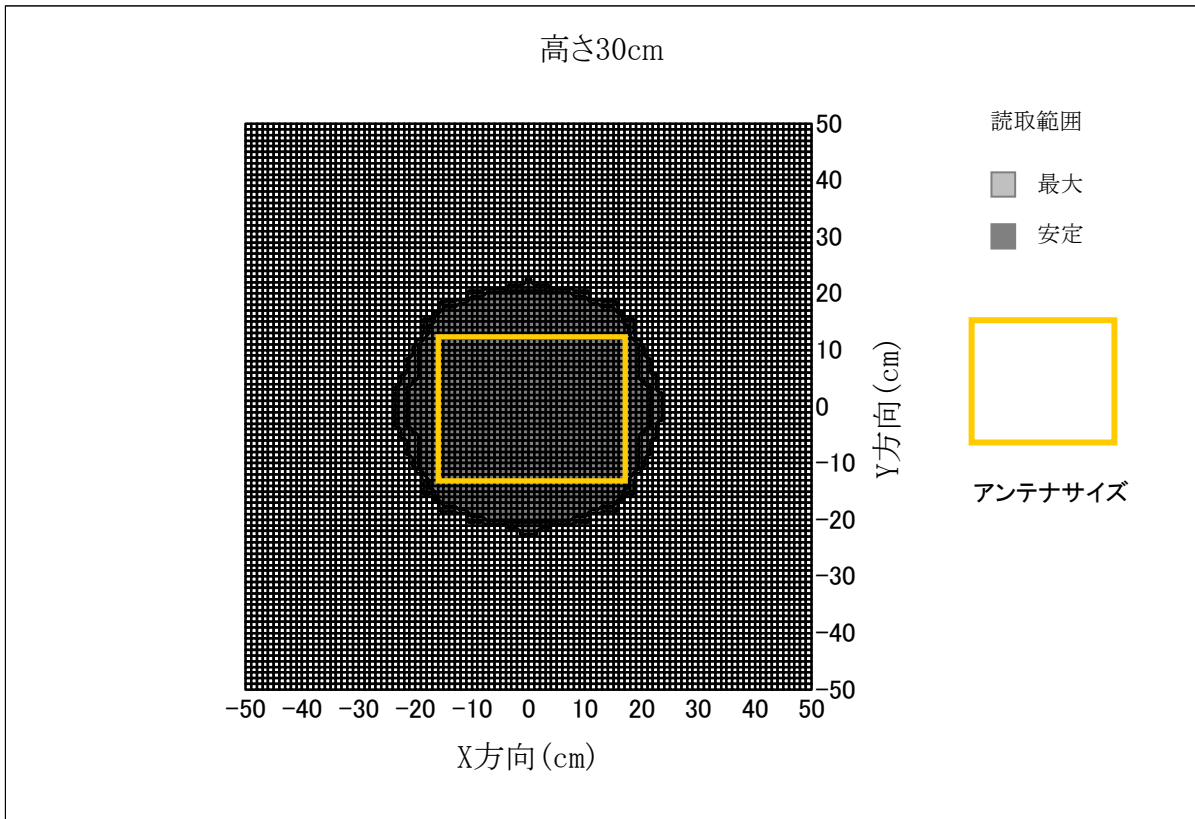

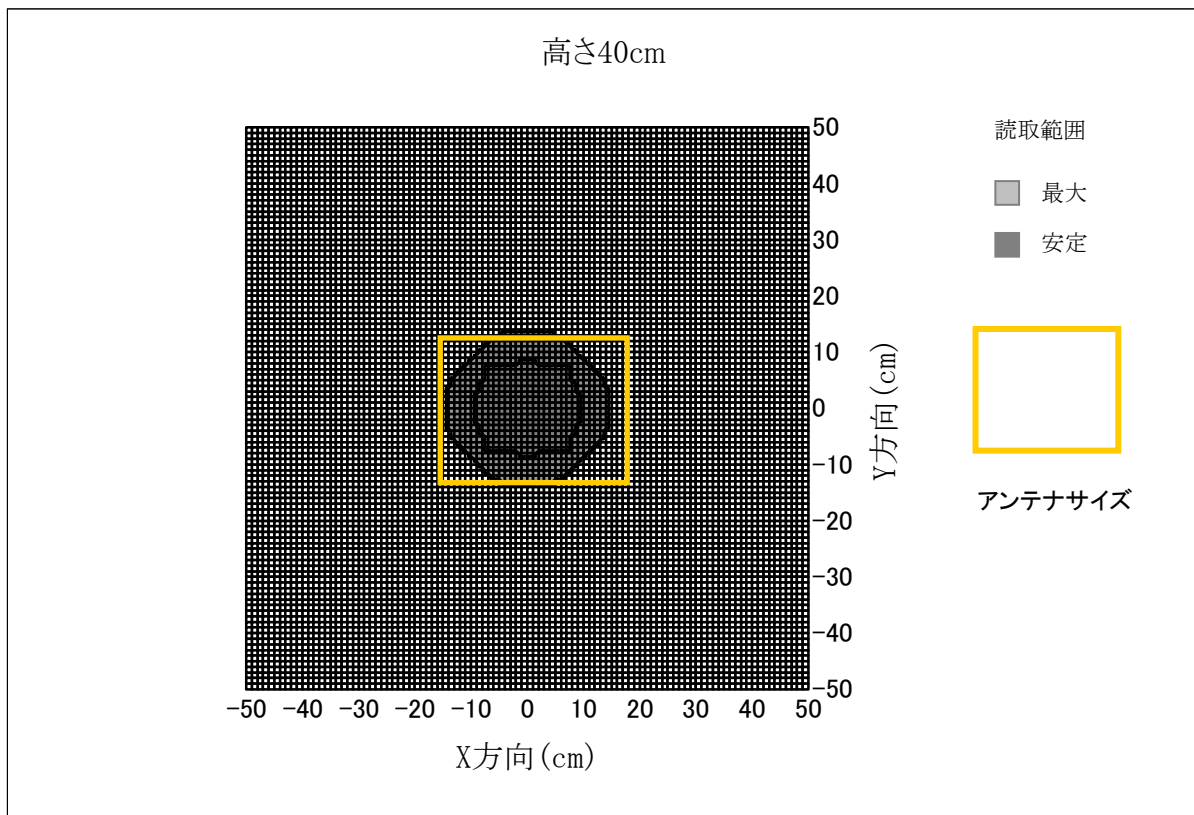

対象アンテナ : TR3-SA101M(外形 : 324×254mm)
 ICタグ : カードサイズ(Tag-it HF-I)
 交信距離 : MAX 25cm

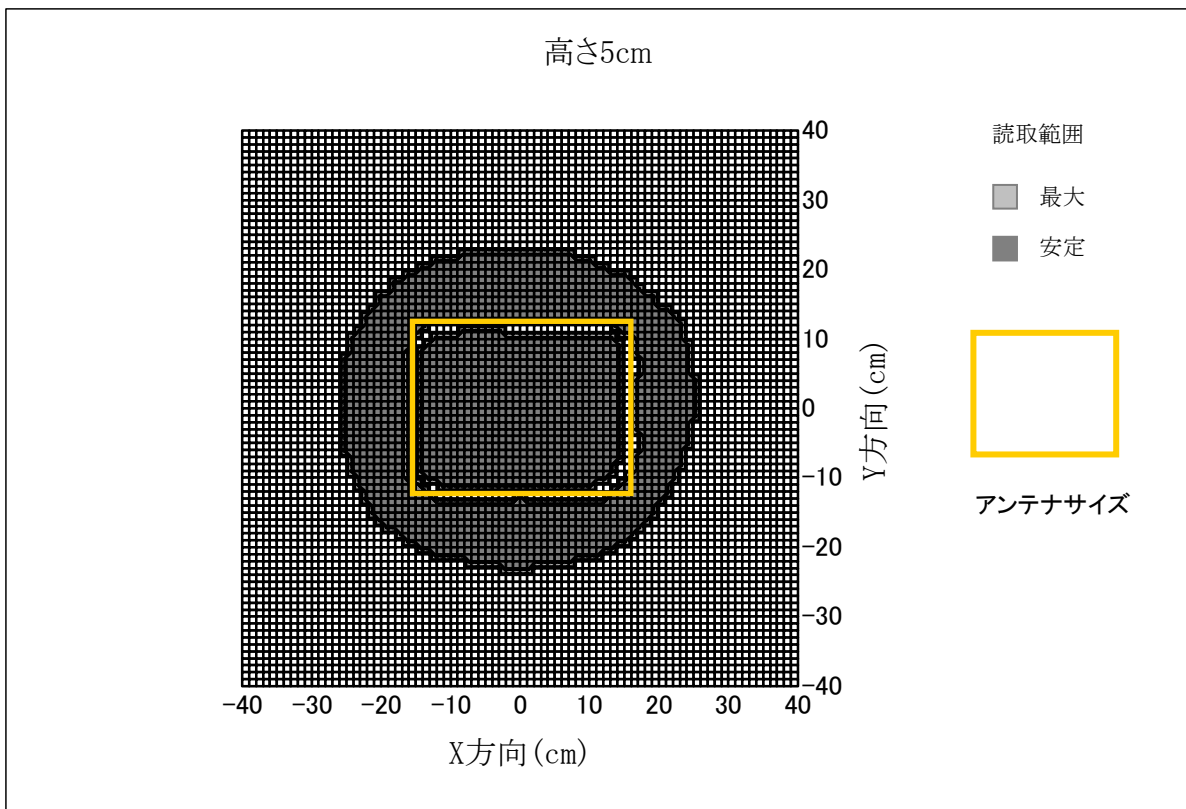
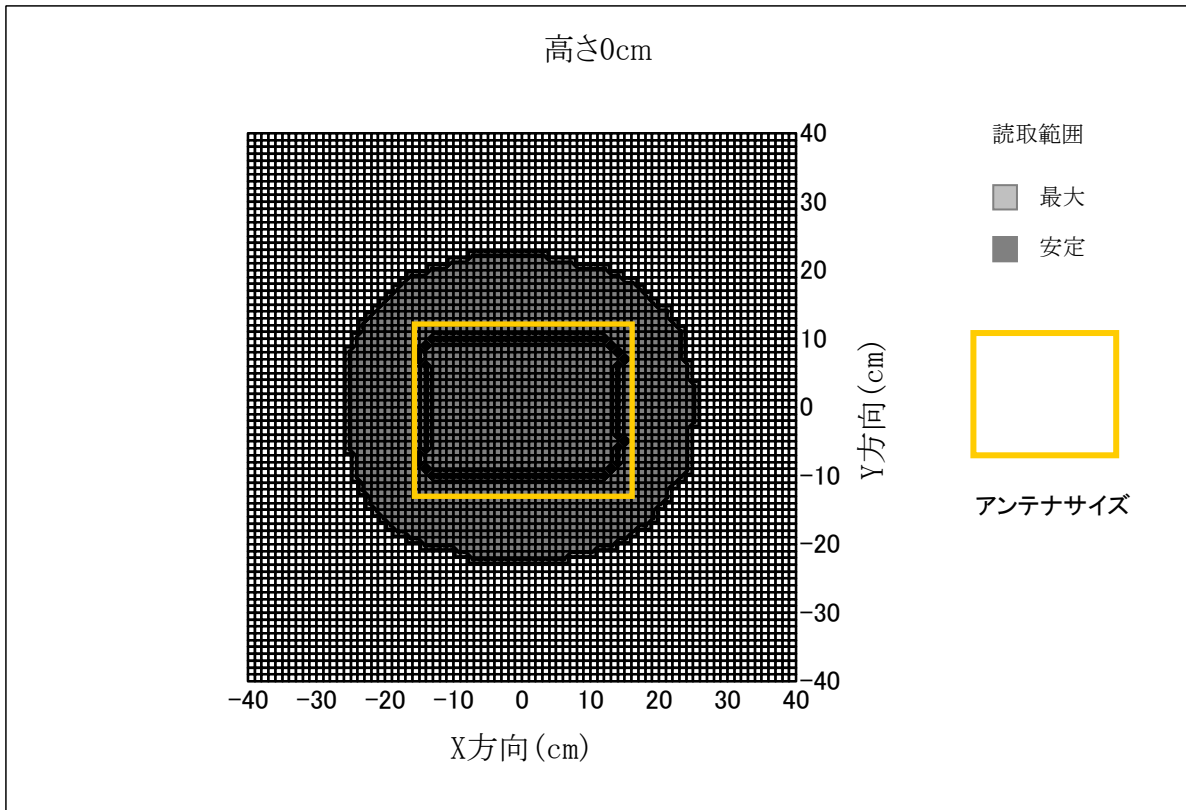

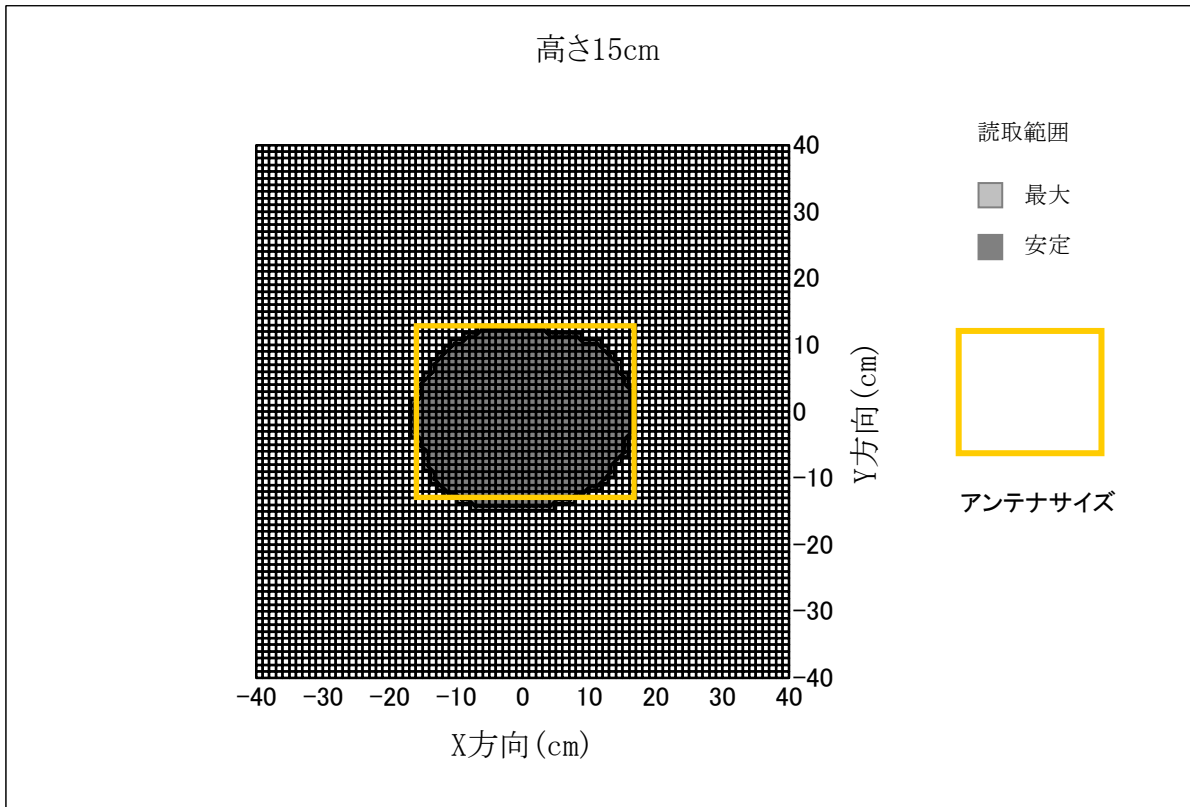
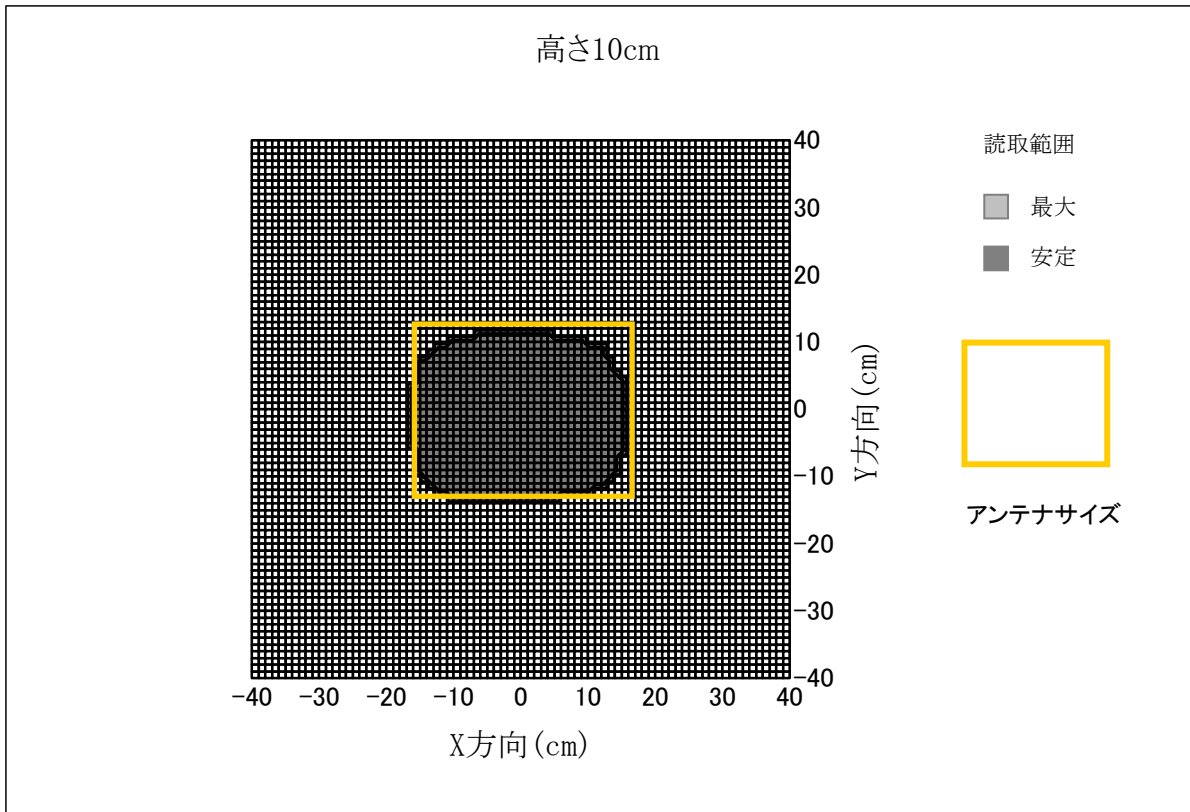

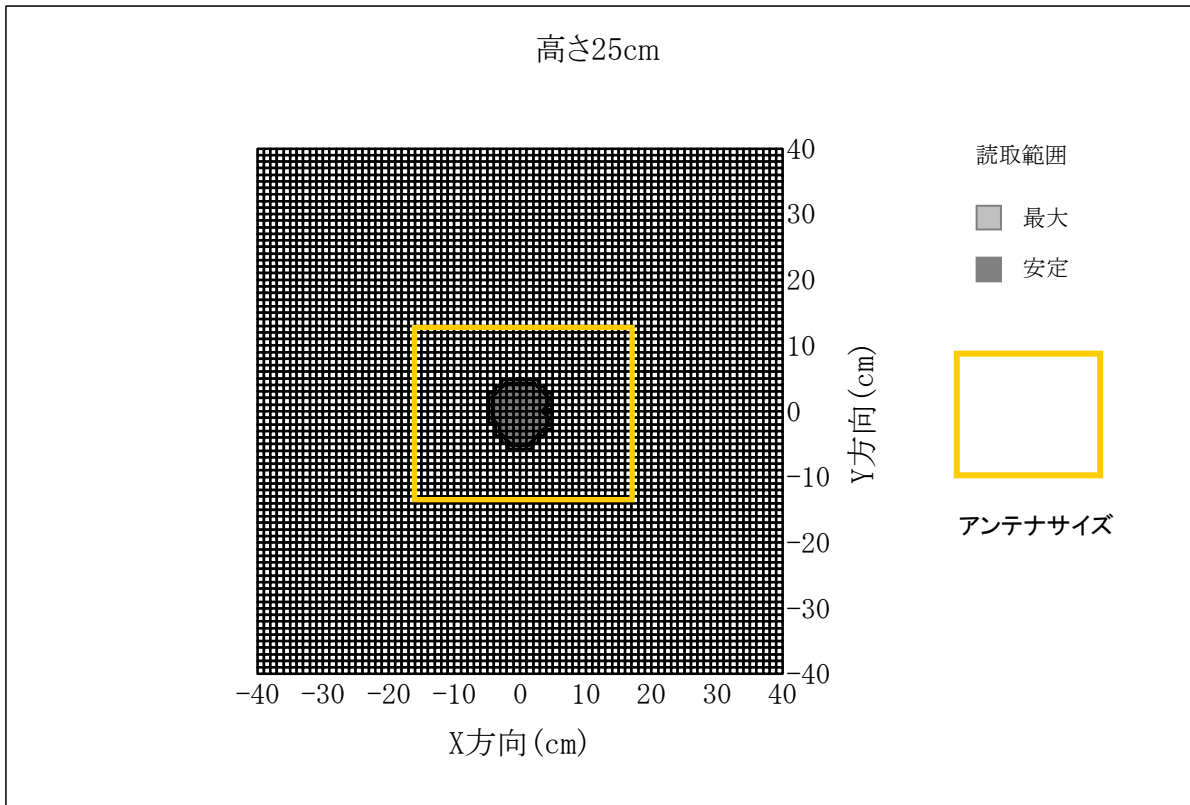
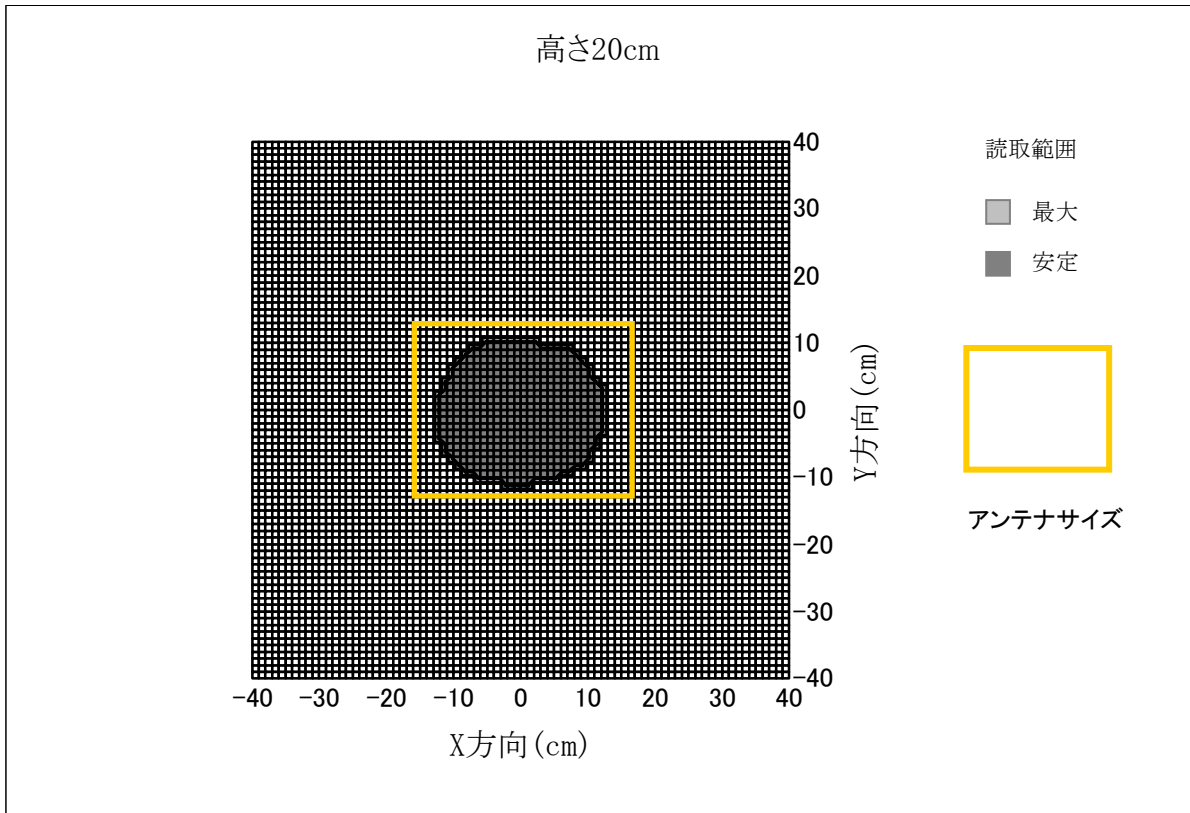

変更履歴

| Ver No. | 日付 | 内容 |
|---------|----------|------|
| 1.00 | 2010/2/1 | 新規作成 |
| | | |
| | | |
| | | |
| | | |
| | | |
| | | |
| | | |
| | | |
| | | |
| | | |
| | | |
| | | |
| | | |
| | | |
| | | |
| | | |
| | | |
| | | |
| | | |
| | | |